

GF 630N03

1. 02



;: *' \$B\$'



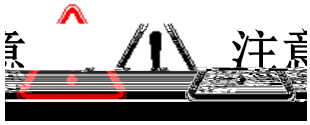

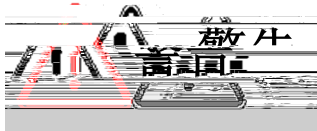
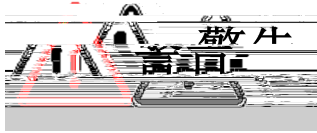

%

F7A
F7A

6

F78

F78
F78

F78

F78

F78

&

)\$\$J

)A»

,

%	1
%"%	1
%"&	3
%"'	5
%"(.....	6
%)	6
%"*	8
%" +	8
%",	8
&	9
&"%	9
&"&	10
&"'	11
&"(.....	11
&")	11
,	12
' "%	12
' "&	13
' "'	15
(.....	21
("%	21
("& @98	21
)	26
)"%	26
)"&	27
)"'	27
)" (.....	27
)")	28
*	31
*" %	D\$	32
*" &	D&	32
*"'	D'	35
*" (D(.....	37
*")	D)	39
*" *	D+	40
*" +	D,	47
*" ,	D-	51
*" - J#:	% D%\$	54
*" %\$ &	D%&	58
*" %% %	D%&	59
*" %& &	D%	62
*" %	D%(.....	65
*" %(D=8	D%)	66
" %)	D%	68
" %	D%	69
*" %+	D&\$	71
*" %	D&%	72
*" %&	D&'	74

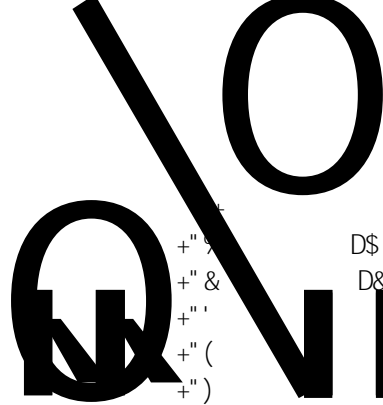

.....	77
+ " % D\$	77
+ " & D&	78
+ " ' D'	83
+ " (D(.....	91
+ ") D)	94
+ " * D+	97
+ " + D,	105
+ " , D-	120
+ " - J# : % D%\$	125
+ " %\$ D&%	126
+ " %% D%	133
, " %	134
, " &	138
-	139
- " %	139
- " &	139
- " '	140
- " (.....	141
- ")	141
5 AC86l G	142
5" % AC86l G	142
5" % %	143
5" &	146
5" & " % #	146
5 & " "	

% &

; : *' \$B\$'

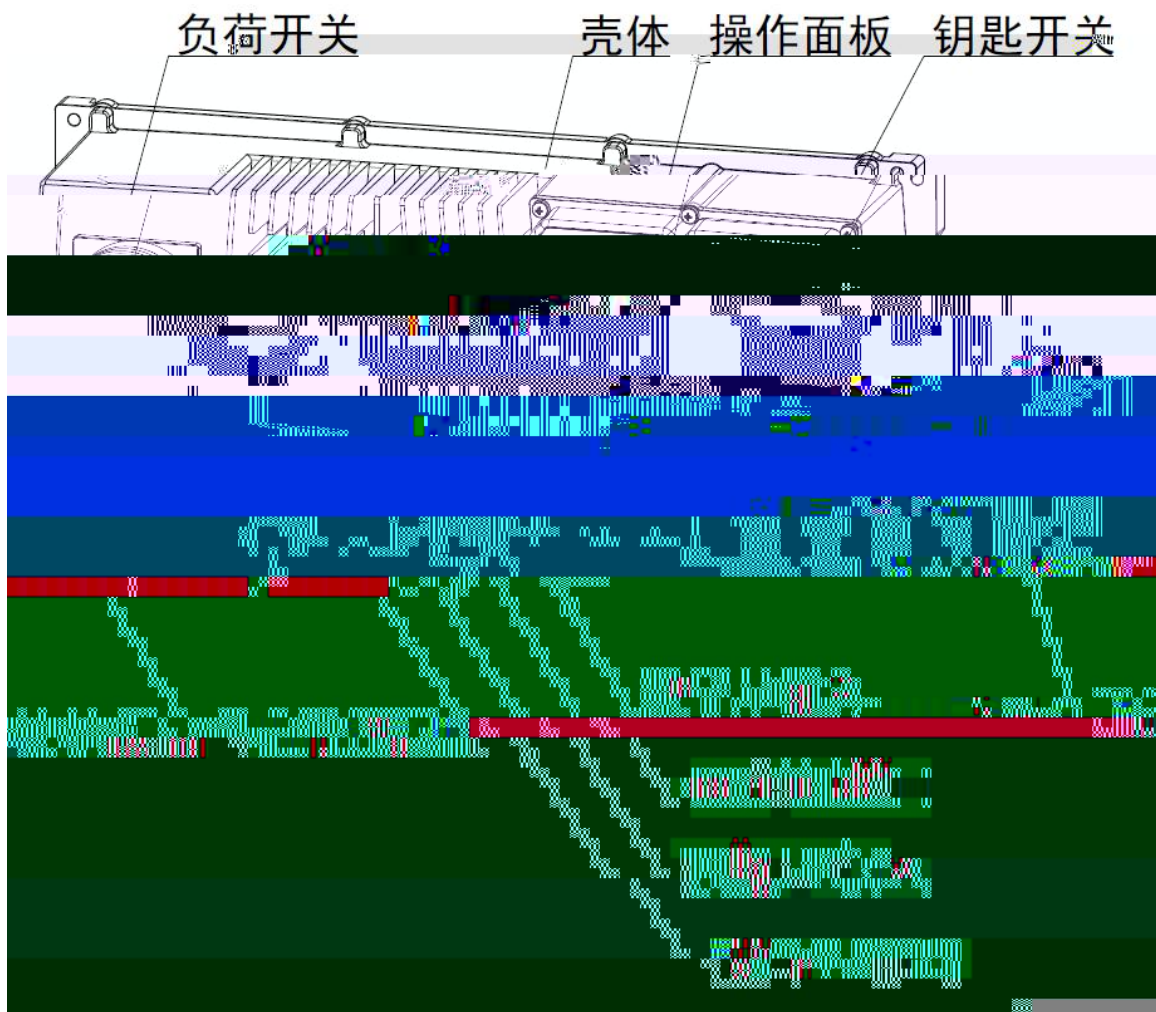

\$" +! &" &_K

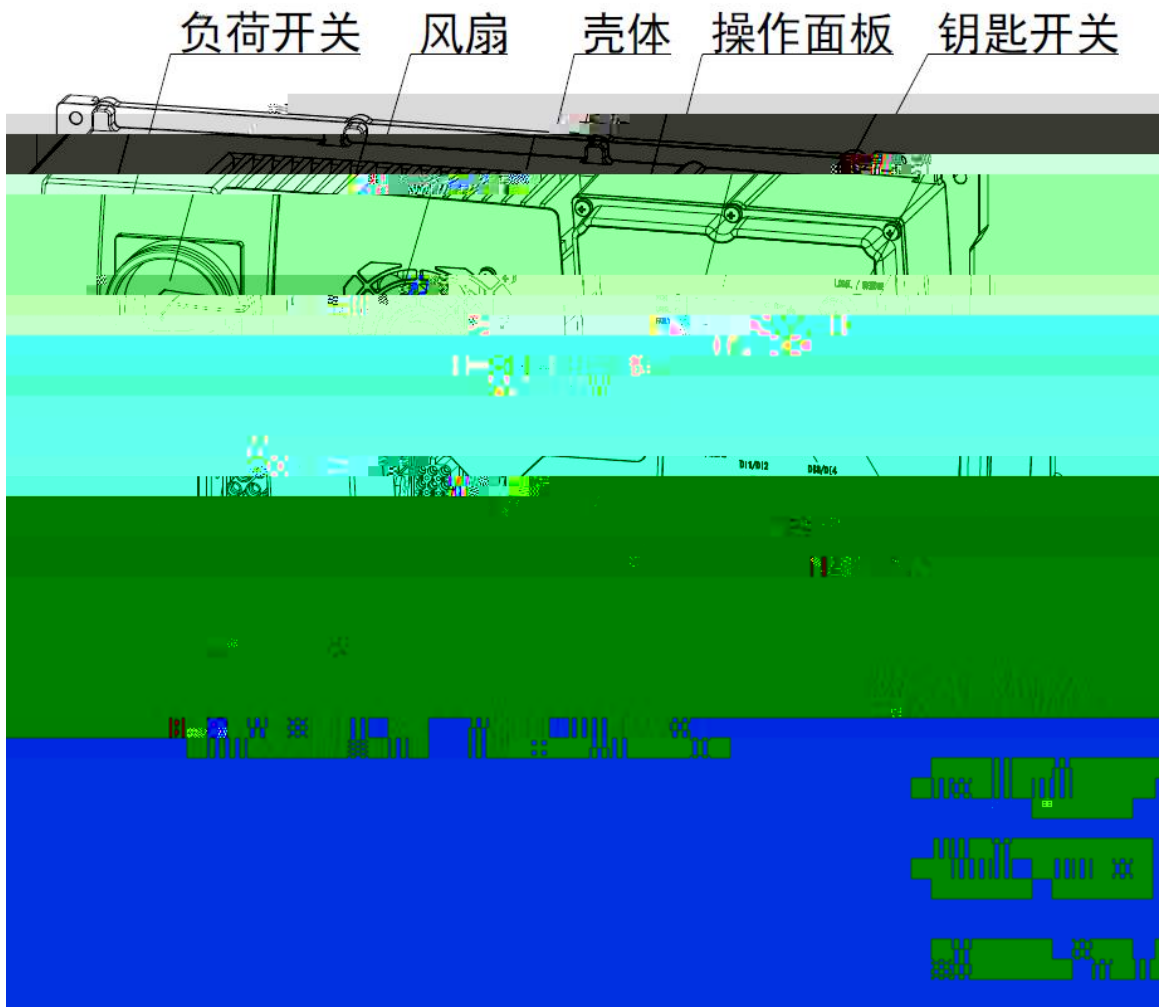

' " +!)")_K

%'

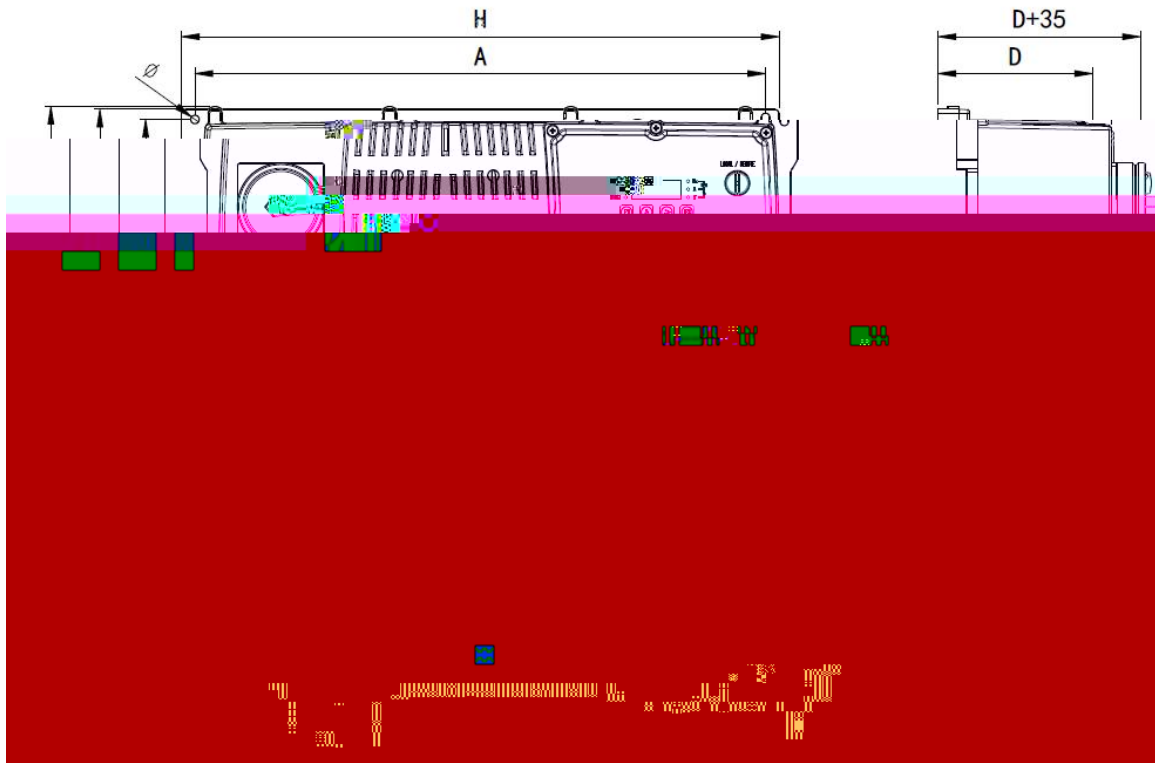

B% \$" +! &" &_K



B& ' " +!)")_K

%" (

	aa				aa		,"]
	<	K%	K&	8	5	6	Đ	A
\$" +_K								
%)_K	((&@	&/\$	%@	(&)	%)	Đ *	(! A) *"
&" &_K								
' " +_K	((&@	&/\$	%@	(&)	%)	Đ *	(! A) +"
)")_K								

*

		% \$i) % % \$i) %g
		G
		GJ7
	D=8	
		#
		%*
		8=8C 8=8C
		(% ! %\$ Ž%\$J
		& &
		%\$\$\$ %\$\$\$ %\$\$ % ' \$\$\$
		! %\$ Ž(\$ (\$ % %)\$! %\$
		-) F<
		! &\$ Ž*\$ %\$! '\$
		=D) (
		&
		, \$XV

% *

(1)

(2)

% \$l

(3)

% +

O_KQ

O_KQ

;: *' \$

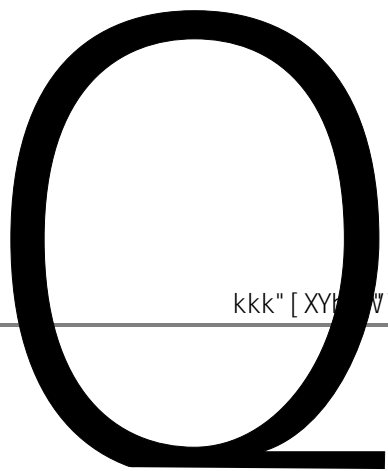



&"'

	5	# aa ⁸	5
		79: F (\$i	f157! ' 7
\$" + _K	&" *	&")	-
%)_ _K	(" \$	&")	-
&" & _K)" +	&")	-
' " + _K	%\$ " &	&")	%&
)")_K	% " \$	&")	%

&" (

	&		%	
\$" + _K	' " \$5	(" *+a<	&" *5	&" * -a<
%)_ _K	(" , 5	&" -&a<	(" \$5	% +) a<
&" & _K	*" , 5	&" \$*a<)" +5	% && a<
' " + _K	%&5	% %+a<	%\$ " &5	\$" * -a<
)")_K	% 5	\$" +, a<	% 5	\$" (+a<

&")

			?K ' \$i ?W	?K) \$i ?W
\$" + _K	+) \$	%\$\$	\$" &	\$" ')
%)_ _K	(\$ \$	%\$\$	\$")	\$" +
&" & _K	&) \$	+,	\$" ,	%
' " + _K	%\$\$	* (&" \$	&")
)")_K	%\$\$	(\$	&" \$	&")

%
& ?W
,

%\$\$i

' "%

' "&

' "&"%

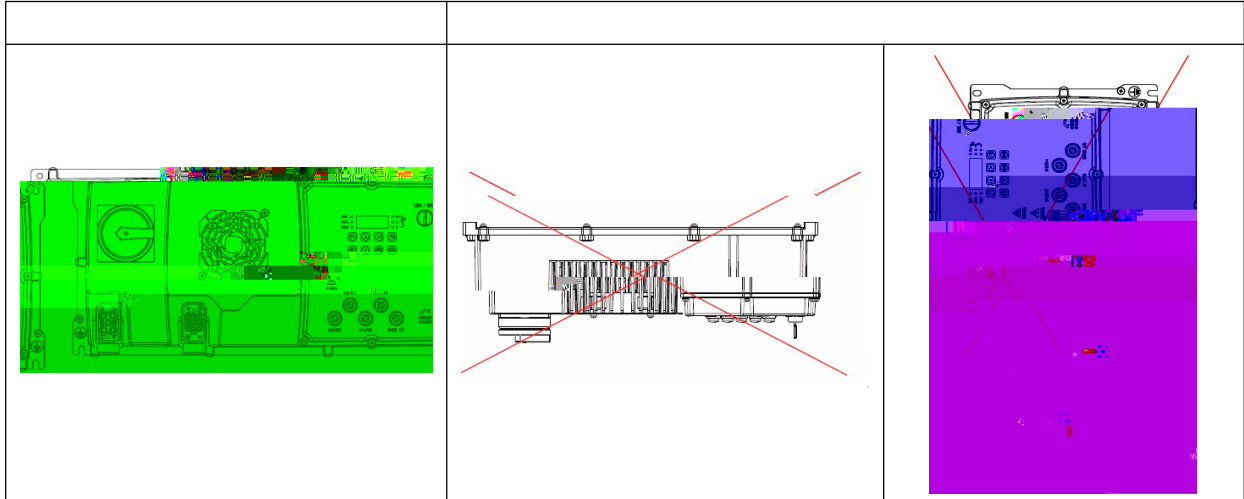

' "&"&

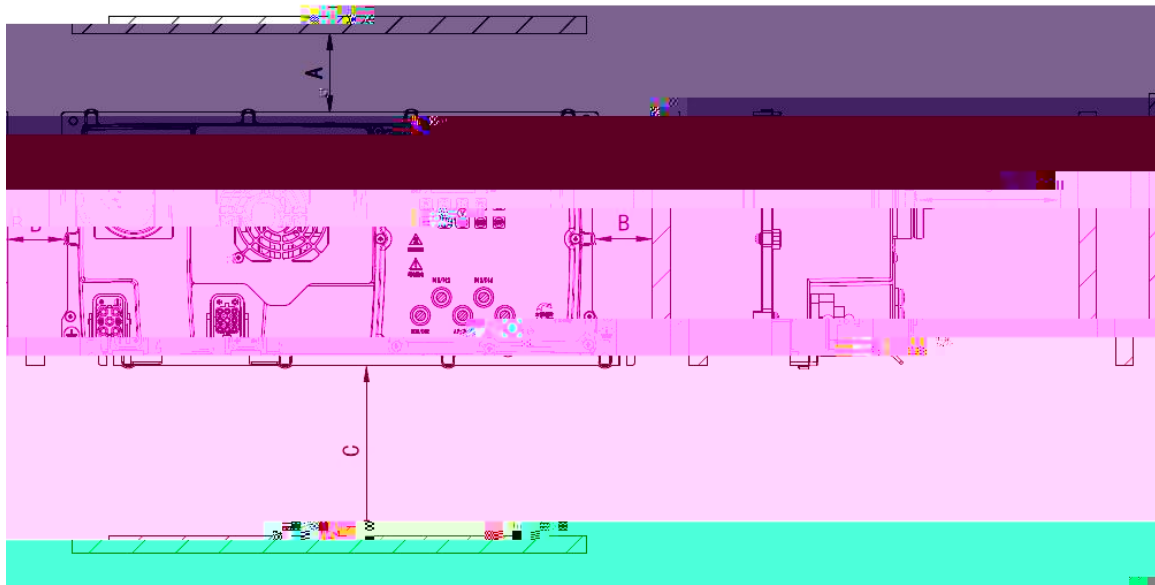

	fl		aał
\$" +_K)")_K	5 %\$\$	6 &\$	7 ' '\$\$

'"&''

%

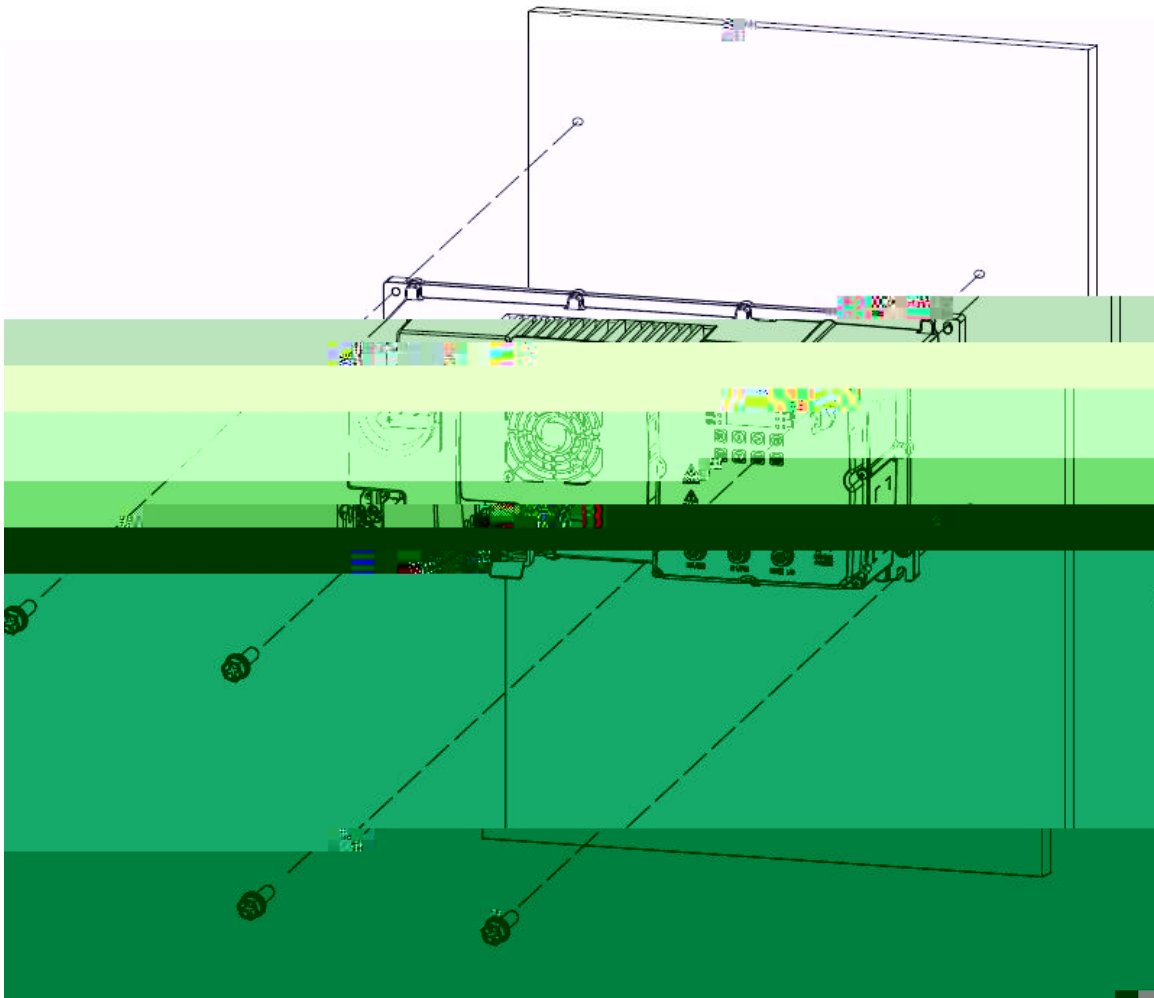

h

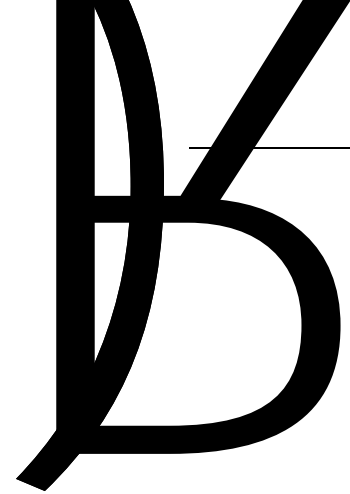

' "' &



&

F G H	
I J K	
DŽ	
86F	
D9	

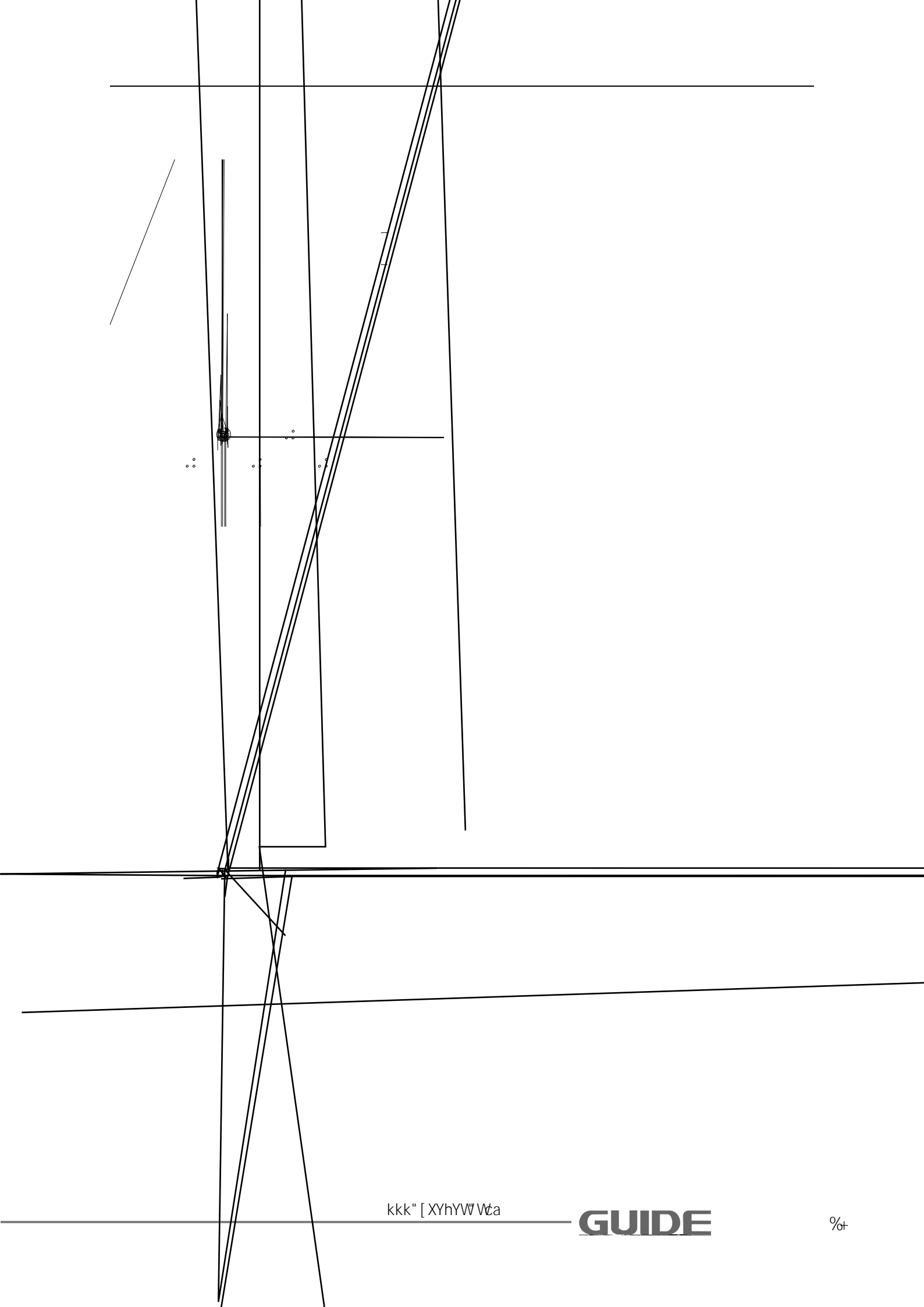

kkk" [XYhYW Včá

GUIDE

9/t

a''

• • • • •

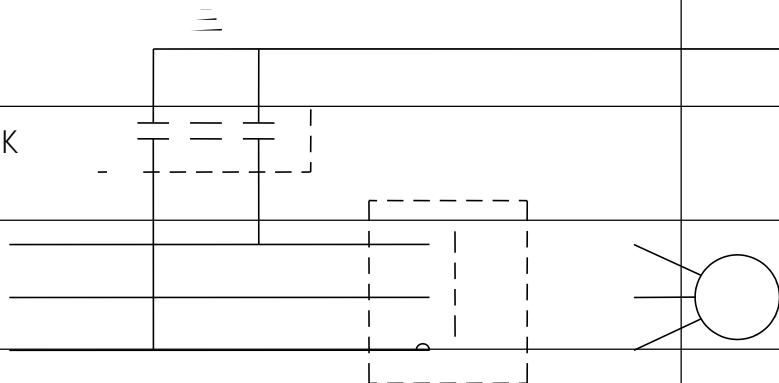

*		
+	I J K	
,		
-	%\$Vø	
%\$) \$a	\$" +) aa
%%		%\$Vø
%&) \$a) \$a
%		
%{		
%ø		' \$ a

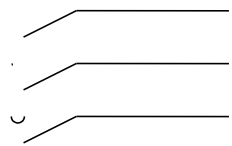



		
		
		#

(" & @98

%

@98

Q



D\$&" '\$ D\$&" \$(

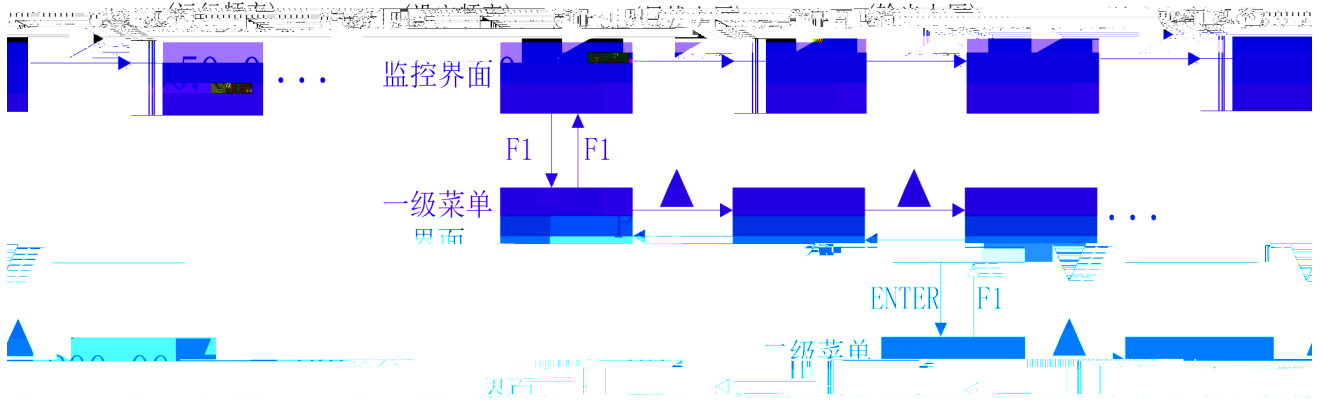

)

:: *' \$B\$'

)"%

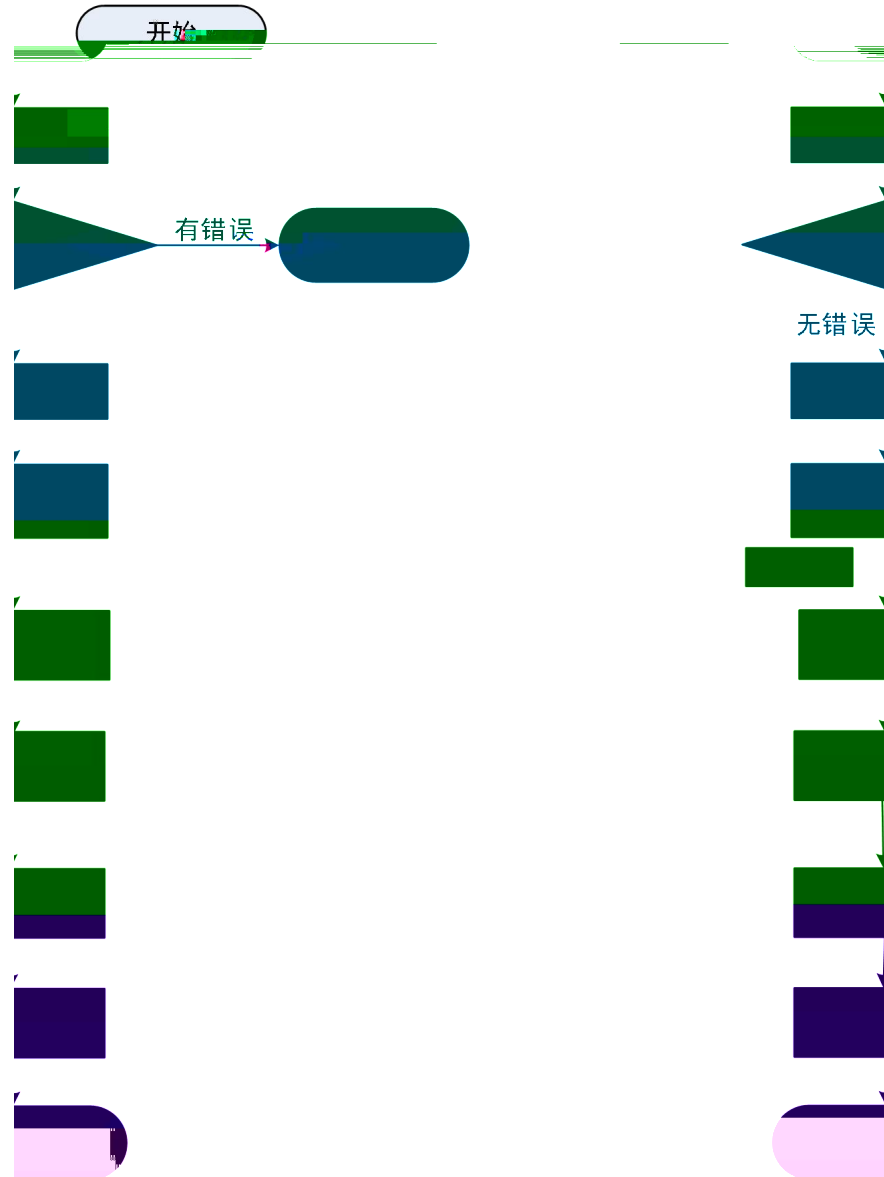

)"&

	57' , \$r (, \$J
)\$#*\$<n
	I žJžK

)"'

@98

)\$" \$\$

9

D\$\$" \$%

D\$\$" \$%	\$. % &	fl fl
		ł
		ł
		\$

)" (

J#:

D\$, " %\$	fl<nł	# # #)\$ O<nQ
D\$, " %&	fl<nł	#	
D%\$"')	fl?Kł		
D%\$"' *	flUł		
D%\$"' +	fl5ł		
D%\$"' ,	fl<nł		
D%\$"' -		flf #a] bł	

	<p>% &" D%\$" +% %& 9BH9 HI B9</p> <p>' " FI B : 5l @H</p>	<p>%" fID%\$") \$L/ &" 8 fID%\$") %L/ ' " E fID%\$") &L/ (" fID%\$") (L/</p>
--	---	--

%
; : *' \$B\$'

)	()\$<n	
*	GHD	

*

D\$		D%&	%
D&		D%	&
D'		D%{	
D(D%)	D=8
D)		D%*	
D+		D%_	
D,		D&\$	
D-		D&%	
D%\$	J#: %	D&'	
D%&	&		

†

*" %

D\$

D\$&" \$'	@98 %	\$\$\$\$: : : : 6] h\$\$ % <n 6] h\$% <n 6] h\$& J 6] h\$' . J 6] h\$(. 5 6] h\$) . _K 6] h\$* . I 6] h\$+ . 8= 6] h\$, . 8C 6] h\$- . 6] h%\$. 5=% J 6] h%% 6] h%& 6] h% . 6] h%{ . 6] h%} . D=8	%	
D\$&" \$(@98 &	\$\$\$\$: : : : 6] h\$\$ D=8 6] h\$% D@7 6] h\$& DI @G9 _<n 6] h\$' & <n 6] h\$(6] h\$) 6] h\$* 5=% J 6] h\$+ 6] h\$, 6] h\$- <ci f 6] h%\$ A] b 6] h%% DI @G9 <n 6] h%& 6] h% 6] h%{ L <n 6] h%} M <n	\$	

		\$\$\$\$: : : :	
		6] h\$. <n	
		6] h\$% J	
		6] h& 8=	
		6] h\$' . 8C	
		6] h\$(.	
D\$&" \$)	@98	6] h\$). 5=% J	..
		6] h\$*.	
		6] h\$+.	
		6] h\$, .	
		6] h\$- . D@7	
		6] h%\$.	
		6] h%% D=8	
		6] h%& D! @G9	_<n
D\$&" \$*		\$" \$\$\$% *") \$\$\$	'
D\$&" \$+		\$" \$ %\$\$" \$!
D\$&" \$,			

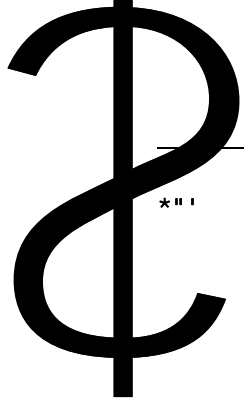

D'

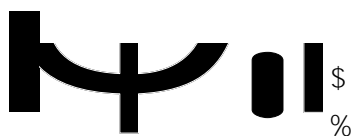

D\$ " \$\$

%

\$

%

&

,

(

)

*

I D

+

8CKB

,

-

\$\$

%%

%&

%

%{

%)

%*

%

%+

&

%

%

%

I D#8CKB

a"

&\$

%

&%

&&

D=8

&'

D@

' % ('
' &
| '
(

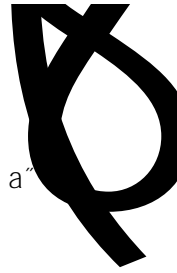

D\$' " %	&	\$ % 8=*	%	
D\$' " %	%	\$" \$g ' *\$\$" \$g	\$" \$g	
D\$' " %*	&	\$" \$g ' *\$\$" \$g	\$" \$g	
D\$' " %+	'	\$" \$g ' *\$\$" \$g	\$" \$g	

*" (D(

D\$(" \$\$				
D\$(" \$%		\$ % & ' : 8H% () % * +		
D\$(" \$&		' - %\$ %% D@7 %& % % % % %*		

		%+	
		%	
		%	
D\$(" \$'	&	&\$	
		&%	\$
		&&	
		&'	&
		&(
		&)	: 8H&

		&*	%
		&+	&
		&	%
D\$(" \$(%	&-	&
		' \$	%
		' %	
		' &	
		' '	
		' ('	
		')	
		' *	

D\$(" \$)		' +	
		' ,	
		' -	
		(\$	

D\$(" \$*			
D\$(" \$+			

D\$(" \$,	&	\$" \$g	' *\$\$" \$g	\$" \$g
------------	---	---------	--------------	---------

D\$(" \$-	%	\$" \$g	' *\$\$" \$g	\$" \$g
------------	---	---------	--------------	---------

D\$(" %\$			
------------	--	--	--

D\$) " &\$	5=	<p style="text-align: center;">5=%</p> <p>% % & D\$) " \$\$ D\$) " '\$</p> <p>& & & D\$) " \$) D\$) " \$,</p> <p>' ' & D\$) " %\$ D\$) " %</p> <p>(((D% " \$\$ D% " \$+</p> <p>)) (D% " \$, D% " %)</p>	' &%	
D) " &%	5=	<p style="text-align: center;">5=%</p> <p>\$. % \$" \$!</p>	\$	

D+

D\$+" \$\$	\$	%
	%	
D\$+" %\$	\$" &\$ %\$" \$\$	%)
D\$+" \$&) \$! %\$!	, \$!
D\$+" '\$	\$ %\$	\$
D\$+" \$(&\$ \$" \$ &&\$ \$" \$	+*" \$
D\$+" \$)	\$ %\$	&\$
D\$+" \$*) \$! &\$!	

D\$+" &&				
D\$+" &'				
D\$+" &(
D\$+" &)				
D\$+" &*				
D\$+" &+				
D\$+" &,				
D\$+" &-				
D\$+"'' \$				
D\$+"'' %				
D\$+"'' &				
D\$+"'' '				
D\$+"'' (
D\$+"'')				
D\$+"'' *				
D\$+"'' +				
D\$+"'' ,				
D\$+"'' -				
D\$+" (\$				
D\$+" (%				
D\$+" (&				
D\$+" ('				
D\$+" ((
D\$+" ()				

D\$+") (\$ % & ' (\$	
D\$+"))		\$! %\$\$" \$! %\$\$" \$! D\$, " %\$	%\$\$" \$\$!	
D\$+") *		\$ % DH/\$\$ & DH/\$\$\$	\$	
D\$+") +		\$ &\$\$	%/\$	
D\$+") ,		\$ &\$\$	- \$	
D\$+" *'		\$ %	\$	
D\$+" * (\$" \$ %\$\$" \$	%\$ " \$\$!	
D\$+" *)		\$" \$ *\$ " \$g	% \$g	
D\$+" **				
D\$+" * +		\$" \$) \$" \$	&\$" \$\$!	
D\$+" * ,		\$" \$g *\$ " \$g	% \$g	
D\$+" * -		\$" \$) \$" \$	&\$" \$\$!	
D\$+" + \$		\$" \$g *\$ " \$g) " \$g	
D\$+" + %		\$ %\$\$	(\$	
D\$+" + &		\$ %\$\$	' \$	
D\$+" +'		\$" \$ ' \$\$" \$	&\$" \$	
D\$+" + (
D\$+" +)	*	\$ % \$ % %+\$)% %\$	

*" +

D,

D\$, " \$\$

D\$, " \$%

%

\$
& J#:

GJ7

\$

D\$, " \$&

\$
%
&

@98
@98
@98

%

D\$, " '\$

L

\$
I D#8CKB
%
I D#8CKB
&
' 5=%
(
)
*
+ D@7
, D=8
-

D\$, " \$,

D\$, " \$,

⌘
\$

D\$, " \$(

M

D\$, " '\$

L

\$

D\$, " \$)



ž ž c c L
%

& L M

D\$, " \$+

' L

\$

(M

\$ ž
% !
&
'

D\$, " \$,

" \$\$<n

D\$, " %\$

) \$" \$\$<n

' .. žž
D\$, " \$-

łł

! ņ\$
%

\$

D\$, " %\$

) \$" \$\$<n

' .. žž

D\$, " &		\$ % &	\$	
D\$, " &-		\$ % &	\$	
D\$, "' \$		% %\$\$	&\$	
D\$, "' %		\$" \$\$<n %\$" \$\$<n	\$" \$\$<n	
D\$, "' &		\$" \$g %\$\$" \$g	\$" \$g	
D\$, "' #	#	\$l %\$\$l	\$l	
D\$, "' (#	\$" \$g %\$\$" \$g	\$" \$g	
D\$, "')		\$ % G 5 & G 6	\$	
D\$, "' * G	G	\$" \$l %\$\$" \$l ! D\$, "' +	' "\$" \$l	
D\$, "' + G	G	\$" \$l %\$\$" \$l ! D\$, "' *	' "\$" \$l	
D\$, "' ,		\$ %	\$	
D\$, "' -		\$" \$\$<n	\$" \$\$<n	
D\$, " (\$		\$" \$g %\$\$" \$g	\$" \$g	
D\$, " (%		\$l %\$\$l	\$l	
D\$, " (&		\$" \$g %\$\$" \$g	\$" \$g	
D\$, " ('		\$l %\$\$l	%\$\$l	
D\$, " ((\$g *) \$\$\$g	\$g	
D\$, " ()				
D\$, " (*				
D\$, " (+				
D\$, " (,				
D\$, " (-				

D\$- " &+

D@7

\$

%

\$

\$

%

D\$- " &

D@7 \$

D\$- " (&

D@7 +

\$" \$g \ (*))' ")g \

\$" \$g \

D%\$" &% J:

)\$ &\$ \$i

) \$i

D%\$" &&

*) \$" \$Jr, \$" \$J

+*" \$" \$J

D%\$" &'

\$
%

\$

D%\$" &(

\$ %\$\$

' \$

D%\$" &)

\$ %\$\$

' \$

D%\$" &*

\$)\$<n

?

3/4

kkk" [XYhYWVta

)*

0
%
0

GUIDE



D%%" %

\$ %&

\$

D%%" &\$

\$" %\ *))' ")J

D%%" &%

\$ *\$\$\$\$

\$

D%%" &&r

D%%" &*

D%&" \$,		\$ &\$\$	* (
D%&" \$-		\$ D%&" %\$ % & 5=% ' () * + %& +	\$	
D%&" %\$		\$" \$! &\$\$" \$!	% \$" \$\$!	
D%&" %%		\$ D%&" %& % & 5=% ' () * + %& +	" \$" \$!	
D%&" %&		\$" \$! &\$\$" \$!	% \$" \$\$!	
D%&" %		\$ *\$\$\$\$	&\$\$\$	
D%&" %&		\$ *\$\$\$\$	% \$\$	
D%&" %&		\$ *\$\$\$\$	&\$\$\$	
D%&" %*		\$ *\$\$\$\$	% \$\$	
D%&" %+		\$ %	\$	
D%&" %		\$. % &	%	

*\$

D%&" (\$				
D%&" (%)		\$, \$)\$	
D%&" (&	GJ7	\$ %	\$	
D%&" ('		\$ %	\$	
D%&" ((\$" \$\$\$ D%&" \$\$	"' \$<n	
D%&" ()		% %\$\$	%\$	
D%&" (*		" %g %" \$\$g	") \$g	
D%&" (+		\$ %	\$	
D%&" (,		" \$v %" \$v	" , v	
D%&" (-		\$z%z&	\$	
D%&") \$		\$z%	\$	
D%&") %	GJ7	\$r' *"\$ \$	\$	

*" %& & D%

D% " \$\$\$	%	% %\$\$	' \$	
D% " %g	%	" %g %" \$\$g	") \$g	
D% " &&	%	" \$\$\$ D% " \$)) " \$\$<n	
D% " \$'	&	% %\$\$	&\$	
D% " \$(&	" %g %" \$\$g	% \$\$g	
D% " \$)	&	D% " &&	%\$ " \$\$<n	
D% " \$*) \$i &\$ \$i	%\$ \$i	
D% " \$+		" \$\$\$g "\$ %\$\$g	" \$\$\$g	
D% " \$,		\$ &\$ \$	* (

	\$ D% " %\$	
	%	
	& 5=%	
	,	
D% " \$-	(\$
)	
	*	
	+	
	% +	D% " %\$
D% " %\$	\$" \$! &\$"\$ \$!	% "\$ "\$!
	\$ D% " %&	
	%	
	& 5=%	
	,	
D% " %%	(" "\$!
)	
	*	
	+	
	% +	D% " %&
D% " %&	\$" \$! &\$"\$ \$!	% "\$ "\$!
D% " %	\$ *\$\$\$\$	&\$\$\$
D% " %&	\$ *\$\$\$\$	% \$\$
D% " %&	\$ *\$\$\$\$	&\$\$\$
D% " %*	\$ *\$\$\$\$	% \$\$
D% " %+	\$	\$
	%	
	\$.	
D% " %	%	%
	&	

D% "%		\$)\$)	
D% " &\$				
D% " &%				
D% " &&		\$Z%	\$	
D% " &'	&	\$ GJ7 % :J7 & J#:	\$	
D% " &(&	\$ % % % & & ' ' ((\$	
D% " &)		" \$! \$"% ' "\$ \$!		
D% T" &*				
D% " &+		\$ %\$\$		
D% " &		%)\$!)!	
D% " &-)\$! % \$!	, \$!	
D% "' \$		\$Z%&	\$	
D% "' %				
D% "' &)\$)\$\$	%\$\$	
D% "' '		\$Z%	\$	
D% "' (\$	\$	
D% "')	?d	% %\$\$	*	
D% "' *	?]	% %\$\$	*	
D% "' +				
D% "' ,	GJ7	%\$ %\$\$\$	%\$\$	
D% "' -	GJ7) &\$\$	(\$	
D% " (\$	GJ7) &\$\$	' \$	

* (

D% " (%	GJ7	\$, \$l	' \$l	
D% " (&	GJ7	\$" , ? D\$, " %	%) ?	
D% " ('		\$Z%	\$	
D% " ((\$ %\$\$\$	&\$\$	
D% " ()				
D% " (*		\$, \$)\$	
D% " (+	GJ7	\$ %	\$	
D% " (,		\$ %	\$	
D% " (-		\$" \$\$ D%&" \$&	\$" ' \$<n	
D% ")\$		% %\$\$	%\$	
D% ")%		\$" %g %\$" \$\$g	\$") \$g	

*" %

D%&

D%&" \$\$

AC86l G

\$ ' \$\$6DG

% * \$\$6DG

& %&\$\$6DG

' &(\$\$6DG

D%&" %%

((, \$\$6DG

) - * \$\$6DG

* % &\$\$6DG

+ ' , (\$\$6DG

,) + * \$\$6DG

- %& &\$\$6DG

"

D% " \$'

%

*" %

D%*

D%* " \$\$	J8=%	\$) -	\$	
D%* " \$%	J8=&	\$) -	\$	
D%* " \$&	J8='	\$) -	\$	
D%* " \$'	J8=(\$) -	\$	
D%* " \$(J8=)	\$) -	\$	
D%* " \$)	J8=	\$ J8Cl J8= % D%* " \$* J8= J8=% J8=& J8=' J8=(J8=)	\$	
D%* " \$*	J8=	\$ % J8=% J8=& J8=' J8=(J8=)	\$	
D%* " \$+				
D%* " \$,	5== 8=	\$) -	\$	
D%* " \$-				
D%* " %\$	5= 8=	\$ % 5=%	\$	

*

D% " %%	J8C%	\$ 8=l % (\$ D\$(8C	\$	
D% " %&	J8C&	\$ 8=l % (\$ D\$(8C	\$	
D% " %	J8C	\$ 8=l % (\$ D\$(8C	\$	
D% " %&	J8C(\$ 8=l % (\$ D\$(8C	\$	
D% " %&	J8C)	\$ % (\$ D\$(8C	\$	
D% " %*	J8C%	\$" \$g ' * "\$" \$g	" \$	
D% " %+	J8C&	\$" \$g ' * "\$" \$g	" \$	
D% " %	J8C	\$" \$g ' * "\$" \$g	" \$g	
D% " %	J8C(\$" \$g ' * "\$" \$g	" \$g	
D% " &\$	J8C)	\$" \$g ' * "\$" \$g	" \$g	
D% " &%	J8C	\$ % J8C% J8C& J8C HCC? J8C(g. c J8C) J8C)	\$?

& 0 / 0

* " %*

D%

COPIES

D% " \$, 5=)

D% " \$- 5=)

D% " %\$ 5=)

%

! %\$" \$\$J D% " %\$

! %\$\$" \$i Ž%\$\$" \$i

D% " \$,

! %\$" \$\$J

! %\$\$" \$\$i

+\$

GUIDE

kkk /yhYWW

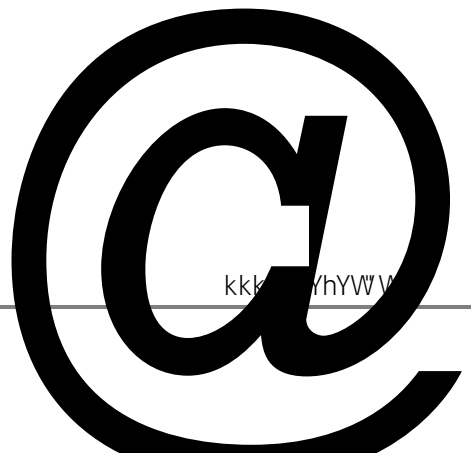

D% " ((
D% " ()				
D% " (*				
D% " (+				
D% " (,				
D% " (-				

*" %t

D&\$

D&\$" \$\$	#	\$ %	\$	
D&\$" \$%		\$ % D&\$" \$' % & 5=% ' () * + % + D&\$" \$'	\$	
D&\$" \$&				
D&\$" \$'		! &\$ \$" \$! &\$ \$" \$!	% \$" \$! \$!	
D&\$" \$(\$ % \$" \$\$	" \$" \$!	
D&\$" \$)		" \$" \$<n) \$" \$" \$<n	
D&\$" \$*		" \$" \$<n) \$" \$" \$<n	
D&\$" \$+		" \$" \$g *) \$" \$" \$g	" \$" \$g	
D&\$" \$,		" \$" \$g *) \$" \$" \$g	" \$" \$g	

*" %

D&%

D&%" \$\$		\$" \$\$<n	&" \$\$<n	
D&%" \$%		\$" \$g *) \$\$" \$g	&\$" \$g	
D&%" \$&		\$" \$g *) \$\$" \$g	&\$" \$g	
D&%" \$'	&	\$" \$g *) \$\$" \$g		
D&%" \$(&	\$" \$g *) \$\$" \$g		
D&%" \$)	'	\$" \$g *) \$\$" \$g		
D&%" \$*	'	\$" \$g *) \$\$" \$g		
D&%" \$+	(\$" \$g *) \$\$" \$g		
D&%" \$,	(\$" \$g *) \$\$" \$g		
D&%" \$-	%	\$" \$\$<n	\$" \$\$<n	
D&%" %\$	&	\$" \$\$<n	\$" \$\$<n	
D&%" %%		\$" \$\$<n	\$" \$\$<n	
D&%" %&		\$" \$g ' \$\$\$" \$g	\$" \$g	
D&%" %		\$ %	\$	
D&%" %&		\$ % &	\$	
D&%" %&		\$" \$i %\$\$" \$i	\$" \$i	
D&%" %*		\$\ *) \$\$\$\	\$\	
D&%" %+		\$\ *) \$\$\$\	\$\	
D&%" %		\$ %	%	
D&%" %	: 8H%	\$" \$\$<n) \$" \$\$<n	
D&%" &\$: 8H%	\$" \$i %\$\$" \$i : 8H%)" \$\$i	
D&%" &%		\$" \$i %\$\$" \$i	\$" \$\$i	
D&%" &&		\$ %	\$	
D&%" &'				
D&%" &(&				
D&%" &)	% &	\$" \$\$<n	\$" \$\$<n	
D&%" &*	% &	\$" \$\$<n	\$" \$\$<n	

D&%" &+		\$	%	\$
D&%" &	: 8H&	\$" \$\$\$<n) \$" \$\$\$<n
D&%" &-	: 8H&	\$" \$! %\$\$" \$!	: 8H&)" \$\$\$!
D&%" ' \$		%	\$" \$\$\$<n) \$" \$\$\$<n
D&%" ' %		%	\$" \$! %\$\$" \$!	\$" \$\$\$!
D&%" ' &	&	\$" \$\$\$<n) \$" \$\$\$<n
D&%" ' '		&	\$" \$! %\$\$" \$!	\$" \$\$\$!
D&%" ' (\$" \$!		

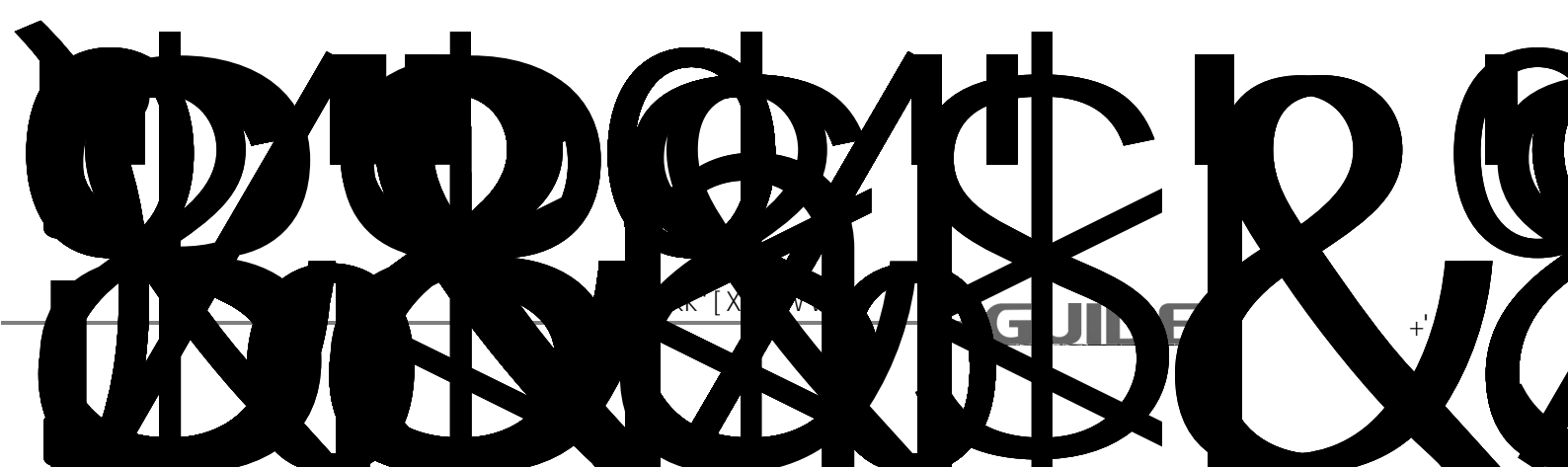

D&' " \$-				
D&' " %\$	5=%	J #	" \$%J#\$" %a5	+\$5<
D&' " %%	a5			
D&' " %&			%	+\$7<
D&' " %			%	+\$8<
D&' " %&			%	+\$9<
D&' " %)	D=8		%	+\$: <
D&' " %*	D=8		%	+\$%<
D&' " %+	D@7		%	+\$%<
D&' " %	DI @G9		" %<n	+\$%<
D&' " %		fl<n	" %<n	+\$% <
D&' " &\$			" %A] b	+\$%<
D&' " &%				
D&' " &&	5=%	J	" \$\$\$J#\$" %a5	+\$%* <
D&' " &				
D&' " &(%a#A] b	+\$% <
D&' " &)			%A] b	+\$% <
D&' " &*			" %A] b	+\$%5<
D&' " &+	DI @G9		%<n	+\$%6<
D&' " &			" %%	+\$%7<
D&' " &-				
D&' "' \$		L	" %<n	+\$%9<
D&' "' %		M	" %<n	+\$% <
D&' "' &			%	+\$&&<
D&' "' '				+\$&%<
D&' "' (%	+\$&&<
D&' "')		fl l	" %\$!	+\$&' <
D&' "' *			%"\$" \$!	+\$&(<
D&' "' +			" %&	+\$&) <
D&' "' ,	56N		%	+\$&* <

D&' "' - J:	%	+\$&+<
D&' " (\$ J:	%	+\$& <
D&' " (% 8=	%	+\$&- <
D&' " (& 8C	%	+\$&5<
D&' " (' 8=	%	+\$&6<
D&' " ((8C	%	+\$&7&" ((

+

+ " % D\$

D\$\$" \$\$			\$
		\$ *)))'	

D\$\$" \$\$

D\$\$" \$\$ \$\$\$\$\$

D\$\$" \$%			\$
		\$	
		%	
		&	

%

D\$\$" \$% %

% fID% 7/

& D\$\$" \$\$\$ D\$\$" \$%/

' D\$+" %(rD\$+")/

(D%\$"' (rD%\$"))ž D%%" \$rD%%" &%/

) D\$&" \$- D\$&" % D\$&" % /

* D\$, "%\$ D\$, "%& /

+ D%&" % rD%&" %*ž D% " % rD% " %* /

&

D\$&" \$-

D\$&" %

D\$&" %

D\$\$" \$&			%
		D&' žD&+	
		\$	

		%	
			D%&ž D% ž D%* ž D% ž D&šž D&%
		\$	
		%	

D\$\$" \$(\$
		\$	
		%	

\$

%

+ " &

D&

D\$&" \$%		: &	\$
			: &
		\$	
		%	
		&	
		(

: &

: &

\$

%

&

: &

,

: &

: >C;

(

: &

F >C;

+,



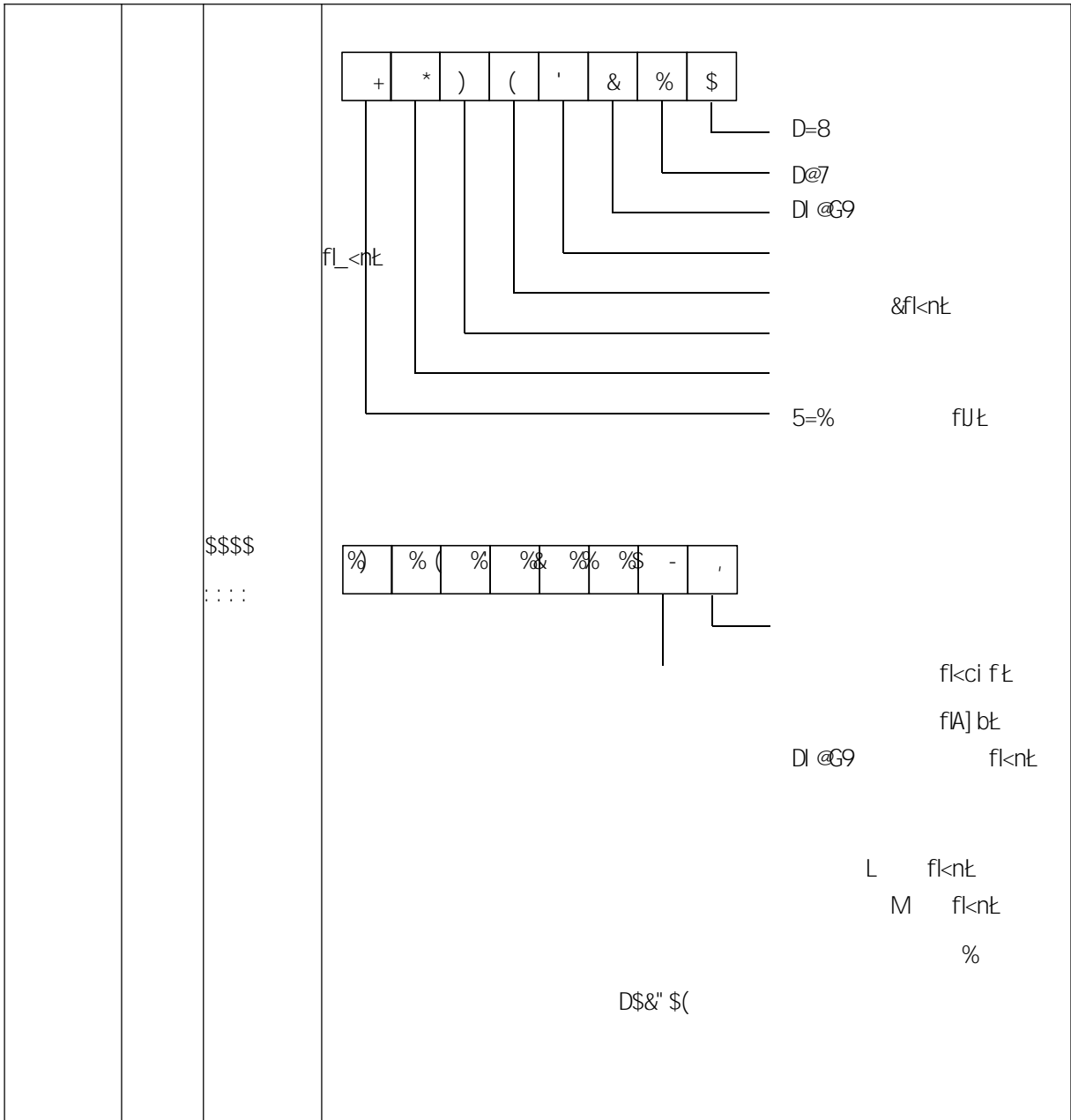

' & D\$&\"' '\$' D\$&\"' '\$(
D\$&\"' '\$'



D\$&" \$+			\$
		\$" \$	%\$\$" \$



%+	&	
%		D\$, " \$+
%	I D#8CKB	I D#8CKB D\$, " \$,
&\$		D\$, " \$&1% D\$, " \$&1&
&%		
&&	D=8	D=8 D=8
&'	D@7	D@7 D@7
&(
&)		
&*		
&+		
&		
&-		
' \$	DI @G9 8=)	8=)
' %		
' &		
''		9\$%\$
' (
')	D=8	D=8 D%\$ " \$'

GHCD

' * %

h a"

' + &

' , 3,8 ° j

B 1 € x



' 3, 95E1 B •

B 1 € x 8 E I
8 † K



2024

13

GUIDE

kkk" [XYhYV



% & ' (

% \$ \$ \$

∅

		\$" \$\$\$g % \$\$\$g
--	--	-----------------------

8=

8=

D\$' "%%			\$
		\$	%
		%	&
		&	%
		'	&

8=% 8=%\$

8=% 8=& 8='

D\$' "\$\$ D\$' "\$&

8=% 8=& 8='

D\$' "\$\$ D\$' \$-

\$

%

8=l

8=m

8=l	%	: K8
8=m	&	F9J

8=l 8=m 8=% 8=%\$

%

&

8=l

8=m

8=l	%	: K8
8=m	&	F9J

8=l 8=m 8=% 8=%\$

& % 8=b 8=l 8=m

8=l	%	: K8
8=m	&	F9J
8=b	'	

8=b 8=l 8=m

8=l 8=m 8=b 8=% 8=%\$
8=l 8=m 8=b

' & 8=b 8=l 8=m

8=l	%	: K8
8=m	&	F9J
8=b	'	

8=b 8=l 8=m

8=l 8=m 8=b 8=% 8=%\$
8=l 8=m 8=b

D\$ " %&	I D#8CKB	% \$\$<n#g
		\$" \$%<n#g *)"')<n#g

I D#8CKB
D, " && & "\$ \$%<n#g *)"')<n#g D, " &&
% "\$ \$%<n#g *)"')

D\$ " %



%&		D&% %t CB
%		CB
%{		CB
%}		CB
%*		
%+		CB
%		CB
%		C :
%		CB
&\$		
&%		
&&		
&'	&	\$ CB CB
&(D&%" % D&%" %* CB
&)	: 8H&	D&%" & D&%" &-
&*	%	D&%" ' \$ D&%" ' %
&+	&	D&%" ' & D&%" ' '
&,	%	D&%" ' , D&%" ' -
&-	&	D&%" (\$ D&%" (%



8C% 8C&

\$

+")

D)

D\$) " \$\$	5=	%	! %\$" \$\$J
			! %\$" \$\$J D\$) " \$&
D\$) " \$%	5=	%	! %\$\$" \$\$I
			! %\$\$" \$\$I %\$\$" \$I
D\$) " \$&	5=	%	%\$" \$\$J
			D\$) " \$\$ %\$" \$\$J
D\$) " \$'	5=	%	%\$\$" \$I
			! %\$\$" \$\$I %\$\$" \$I
D\$) " \$(5=%		\$" %\$g
			\$" \$\$g %\$" \$\$g



+ " *

D+

D\$+" \$\$\$			%
		\$	
		%	
D\$+" \$%			%) \$
	\$" &\$ %"\$ \$\$\$		

D\$+" \$\$\$

D\$+" \$\$\$1%

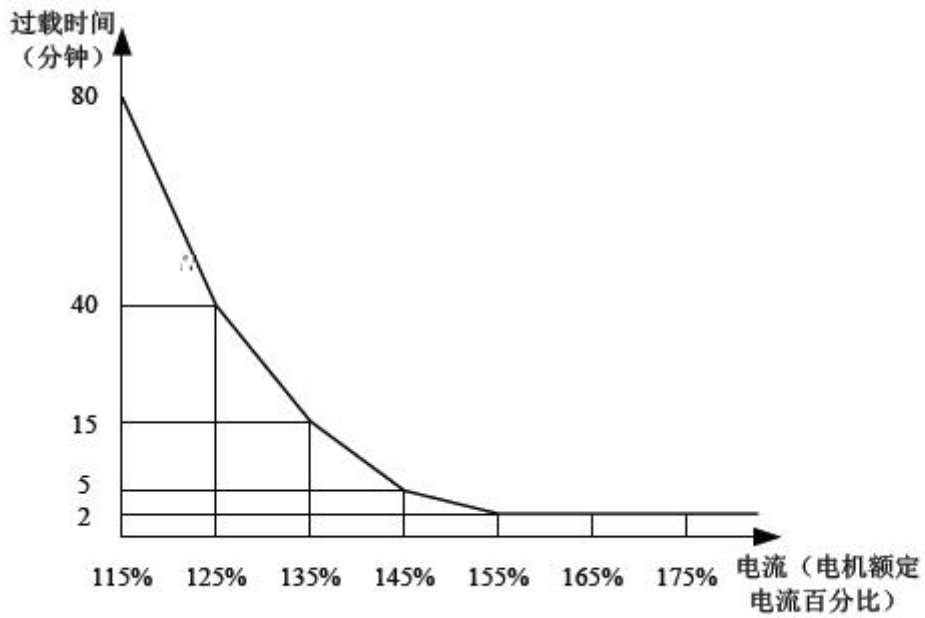

$$I = I_n \times K$$

$$t = \frac{K^2}{I^2} \times t_n$$

D\$+" \$%1%&\$! ... = 1%&\$! ... %&- 1\$" -'

D\$+" \$%

D\$+" \$&			, \$!
-----------	--	--	-------

) \$i %\$\$i
--	--	--------------

8C

D\$+" \$&

8C

CB

D\$+" '\$			\$
		\$	%\$\$
D\$+" '\$(+* '\$" \$
		&\$\$" \$r &&\$\$" \$	

\$

D\$+" \$)			&\$
			\$ %\$\$
D\$+" \$*			% \$i
) \$i &\$\$i

D\$+" \$*

D\$+" \$*

D\$+" %\$

D\$+" %%			%' \$g
		\$" %g %\$\$" \$g	

%%

D\$+" %

|



kkk" [XYhYW



%

\$\$\$\$

9%%

\$

%

D\$+" (+

&

a

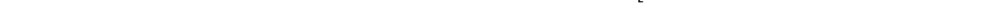

			9\$' \$	
		\$		
		%		
		&	+!	
			D=8	9\$' % D\$+" (+
D\$+") \$	(\$\$\$\$\$
			9%%	D\$+" (+
			9%0	D\$+" (+
			9\$) %	D\$+" (+
			9\$) &	D\$+" (+

9 t

5 t

9 t

5 t

D\$+") (

D\$+") (

		\$	
		%	DH/\$\$
		&	DH/\$\$\$
D\$+") +			%/\$
		\$ &\$\$	
D\$+") ,			- \$
		\$ &\$\$	

DH7 DH7Ž ; B8

; : *' \$B\$' DH7Ž DH/\$\$ DH/\$\$\$
D&' "' (

D\$+") +

D\$+") ,

8C

CB

			\$
D\$+" *'		\$	
		%	
D\$+" *(%" \$i L\$
		\$" \$i	%" \$" \$i
D\$+" *)			% \$g
		\$" \$g	* \$" \$g

D\$+" *)

D\$+" *(

+i

D\$+ " * +

%

& J#:

D%&

%

J: ;: *' \$B\$'

D\$, " \$&			\$
		\$	@98
		%	@98
		&	@98

\$

@C75@

FI B GHCD#F9G

%

@C75@

: K8 F9J >C; : >C; F

&

@C75@#F9ACH

D\$, " \$'	L		\$
		\$	D\$, " \$, I D#8CKB
		%	D\$, " \$, I D#8CKB
		&	
		'	5=%
		(
)	
	*		

+

D@7

,

D=8

-

% %*

D@7

% %*

D-

%\$,

GUIDE

kkk" [XYhYWVta

D\$, " \$)	M		\$
		\$	
		%	L
D\$, " \$*	M		\$
			\$! % \$!

D\$, " \$+ % ' (

D\$, " \$)

L

L

D\$, " \$+		\$
		L
	\$	
	%	
	&	L M
	.	L
	(M
	\$	ž
	%	!
	&	

L

M

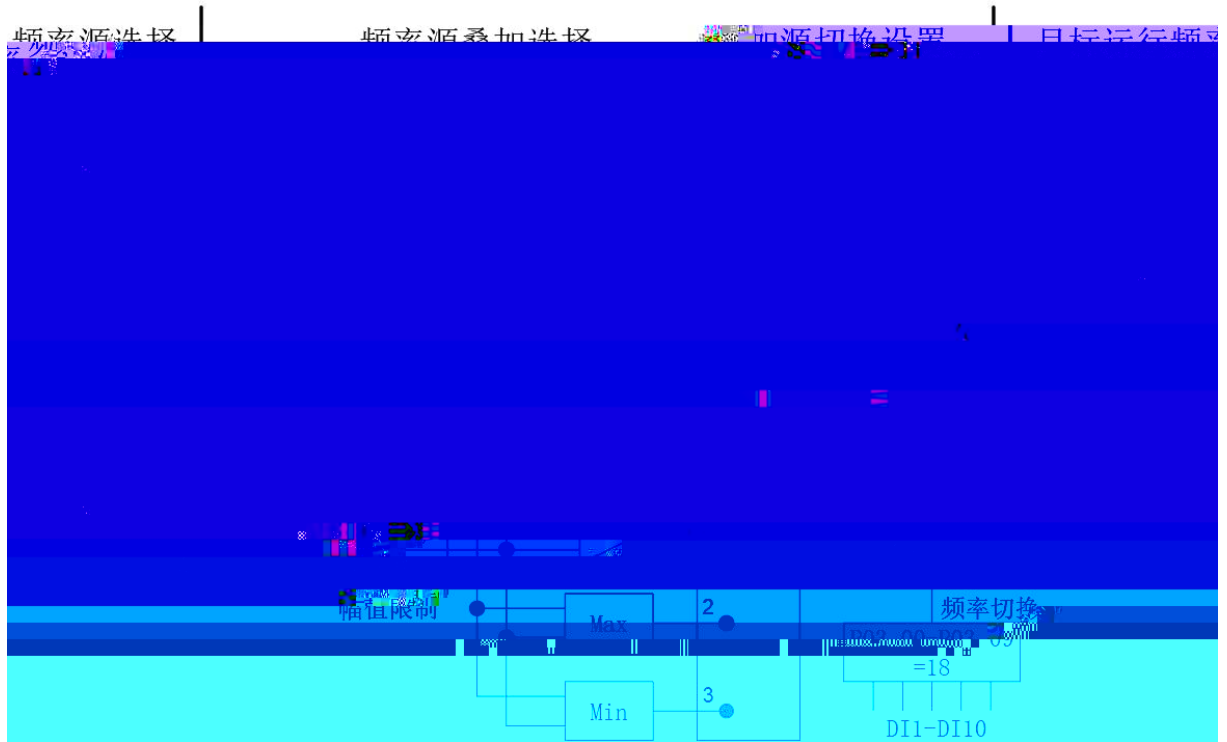

\$ L
 L
 %
 & L M %
 L %
 M
 ' L %
 L %
 (M %
 M %
 \$ Lž M
 L M
 % L! M
 L M
 & A5L L M L M

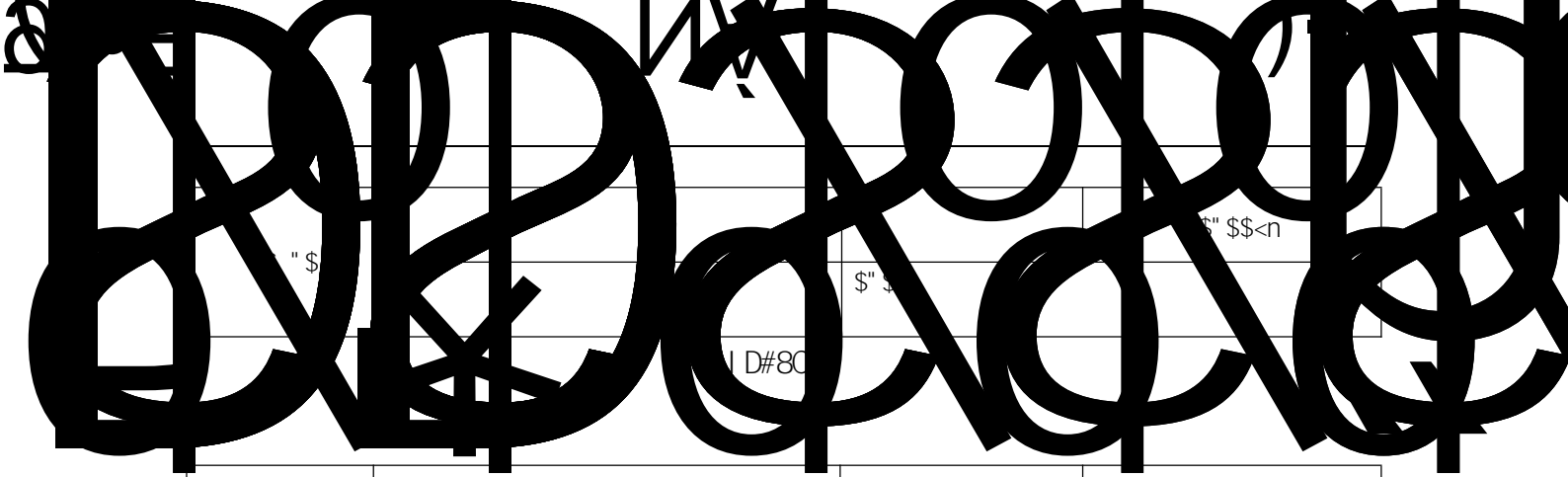

D\$, "\$-			\$
		\$	
		%	

I J K

D\$, "%\$) "\$ \$ \$ <n
)" \$\$<n) \$\$" \$\$<n	

; : *' \$B\$'

8=)



D\$, "%&
%\$\$i D\$, "%&

D\$, "%&)" \$\$<n
			D\$, "%(D\$, "%\$
D\$, "%			" \$\$<n
			" \$\$<n D\$, "%\$

DI @G9 D\$, "%

D\$, "%%

D\$, "%(" \$\$<n
			" \$\$<n D\$, "%&

D\$, "%(

D&%" %((

D\$, "%)			
			")_<n %" \$_<n

D\$, " %			%
		\$	%
		%	\$" %
		&	\$" %

; : *' \$B\$' ' % \$" % \$" %

D,

D\$, " &%			" \$\$<n
			" \$\$<n D\$, " %\$

D, " &%

\$

D\$, " &

\$

%

D\$, " &(

8=

D\$, " &)			\$
		\$	D\$, " %\$
		%	
		&	%%\$<n

D\$, " &)

D\$, " &) %

D\$, " &*	I D#8CKB		\$
		\$	
		%	

I D#8CKB

D\$, " &+			\$
		\$	
		%	
		&	
		'	5=%
		(
)	
	*		

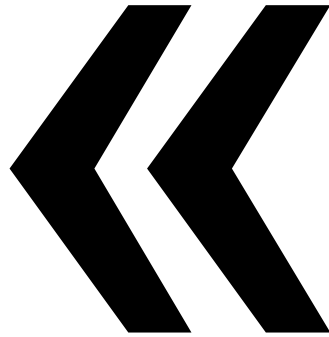
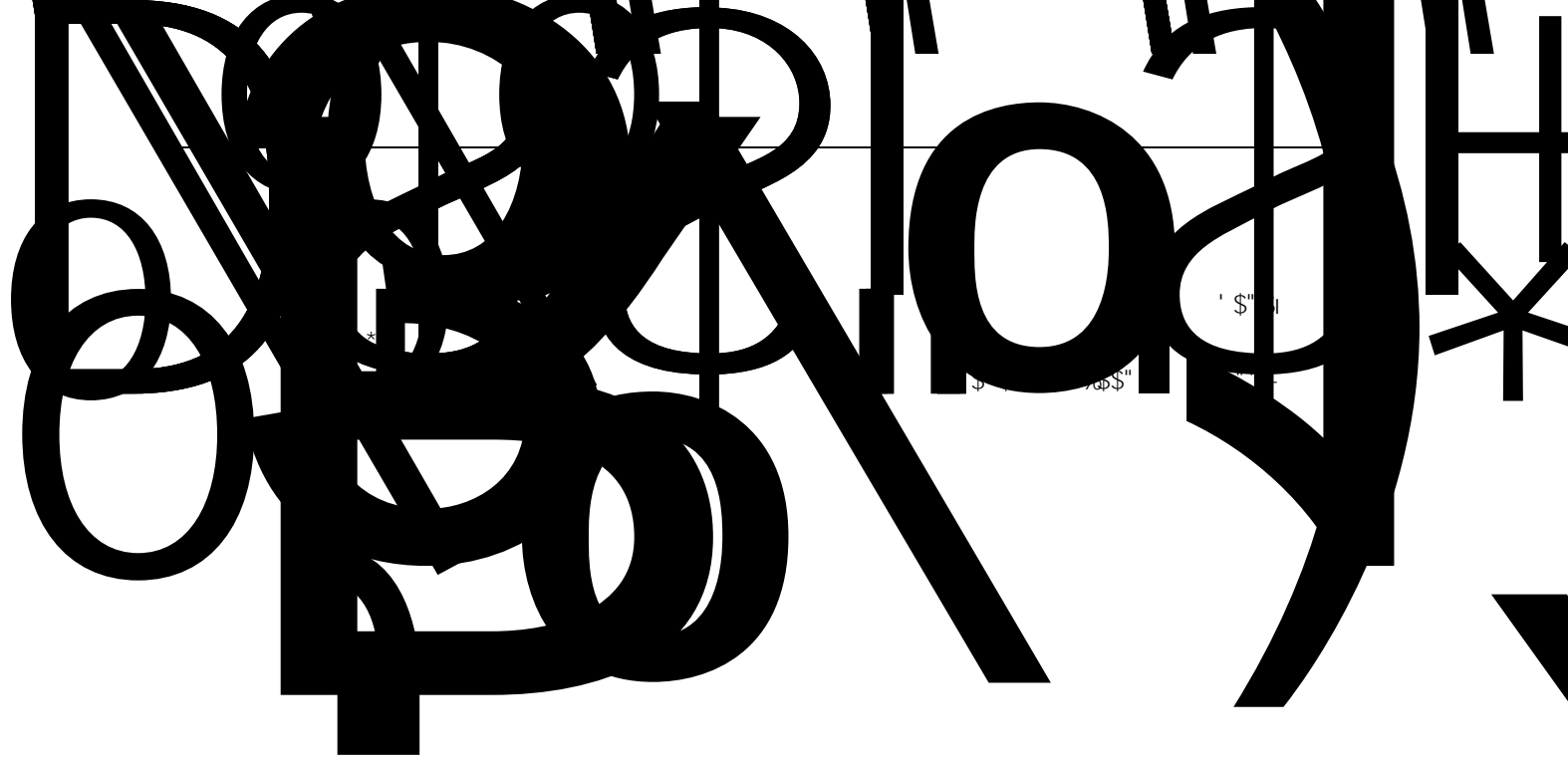

G 6

D\$, " ,			\$
		\$	
		%	

\$
%

\$

D\$, " ' -			\$" \$\$<n
			\$" \$\$<n
D\$, " (\$			\$" \$g
			\$" \$g ' *" \$g
D\$, " (%			\$i
			\$i %\$i
D\$, " (&			\$" \$g
			\$" \$g ' *" \$g

%

, \$i

&

, \$i

, \$i

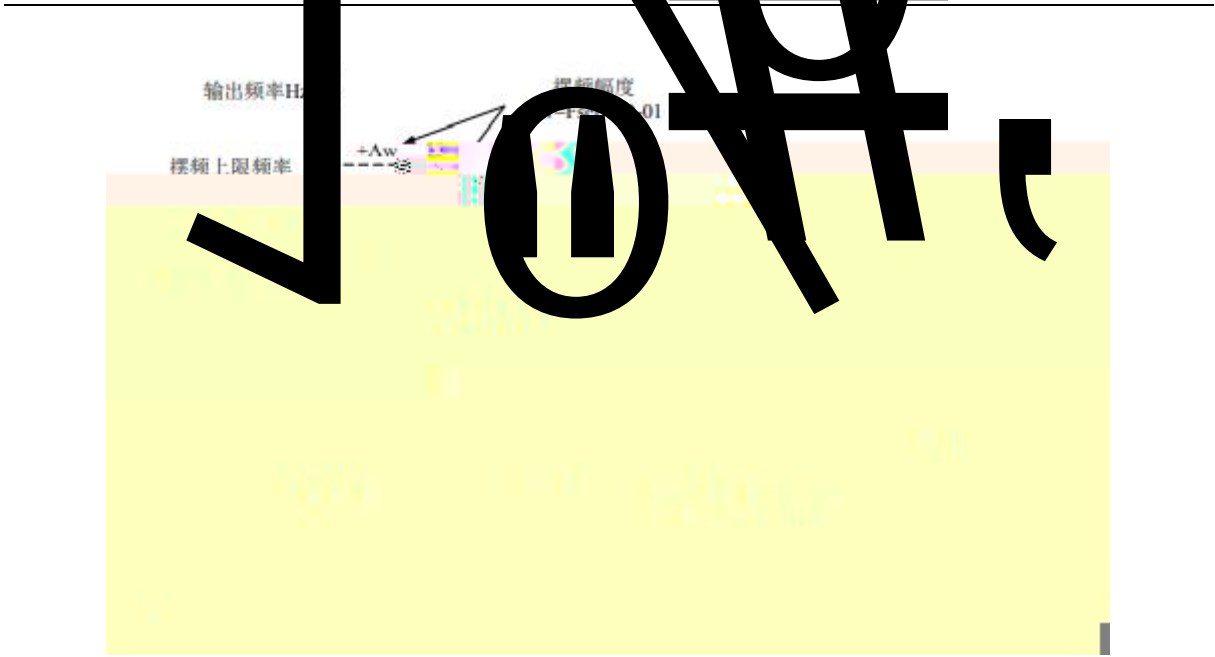

D\$- " \$\$			\$
		\$	
		%	

\$
%

D\$- " \$%			" \$1
			" \$1 %\$ " \$1
D\$- " \$&			" \$1
			" \$1) " \$1

D\$- " \$\$1\$
D\$- " \$\$1%

5K " y
5K y

D\$- " \$%
D\$- " \$%

K ¾
5K K ¾

D\$- " '\$			%\$" \$g
		\$" \$g ' \$\$\$" \$g	
D\$- " \$()\$" \$i
		\$" \$i %\$\$" \$i	

D\$- " \$(

D\$- " '\$

D\$- " '\$ y

D\$- " \$(

D\$- " '\$ y %

D\$- " \$(

D\$- " \$)			%\$\$\$a
		\$a *)') a	
D\$- " \$*			\$a
		\$a *)') a	
D\$- " \$+			%\$\$" \$
		\$" % *)' ")	

D\$- " \$+

D\$- " \$*

D\$- " \$)

8C

CB

8=

8=

&

D'

&+

8=)

D\$- " \$,			%\$\$\$
		% *)')	
D\$- " \$-			%\$\$\$
		% *)')	

&)

8=)

D\$- " \$,



D\$- " \$-

8C

8

CB

D\$- " \$-

D\$- " \$,



; : *' \$B\$'

J:

D=8

D@/

D\$- " %\$

||

0

kkk" [XYhYW Vta

GUIDE

%&'



+ " - J#: % D%\$

D%\$" ')

\$" %_K %\$\$\$" \$_K

D%\$" ' *

%J &\$\$\$J

D%\$" ' +

\$" %\$% *))" ')



D%") \$r%") (

D&% \$%			&\$" \$g
			\$" \$g *) \$\$" \$g
D&% \$&			&\$" \$g
			\$" \$g *) \$\$" \$g

D\$, " &, 1 \$

D\$, "' , 1\$

D&% \$'	&		&\$" \$g
			\$" \$g *) \$\$" \$g
D&% \$(&		&\$" \$g
			\$" \$g *) \$\$" \$g
D&% \$)	'		&\$" \$g
			\$" \$g *) \$\$" \$g
D&% \$*	'		&\$" \$g
			\$" \$g *) \$\$" \$g
D&% \$+	(&\$" \$g
			\$" \$g *) \$\$" \$g
D&% \$,	(&\$" \$g
			\$" \$g *) \$\$" \$g

; : *' \$B\$' (D\$, "%+PD\$, "% ')
 (D\$, "%+ D\$, "%)
 8=
 D\$' " \$% D\$' " \$)

D&% \$-	%		\$" \$\$<n
			\$" \$\$<n
D&% %\$	&		\$" \$\$<n

D&%" % 1%

D&%" %			\$
		\$	
		%	
		&	

; : *' \$B\$'

D&%" %			\$" \$l
			\$" \$l %"\$" \$l

\$

D&%" %

1 y fl l y fl l
D&%" % 1 %"\$" \$l) \$<n) \$l
1) \$<ny) \$l y %"\$" 1&") <n
1) \$<n &") <n 1 (+") <n

D&%" %			%
		\$	%

%

n

D&%' &&

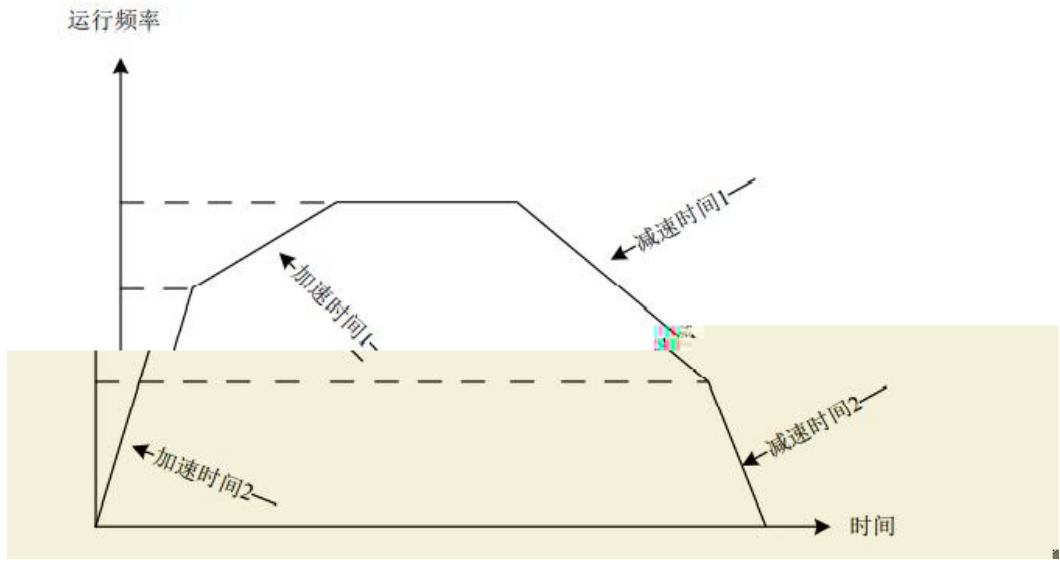

D&%' &)

& D&%' &)

D&%' &*

D&%' &*

D&%' %	%	\$" \$l
		\$" \$l %\$\$" \$l
D&%' &	&)" \$\$<n
		\$" \$\$<n
D&%' ''	&	\$" \$l
		\$" \$l %\$\$" \$l

8C

CB
; : *' \$B\$'

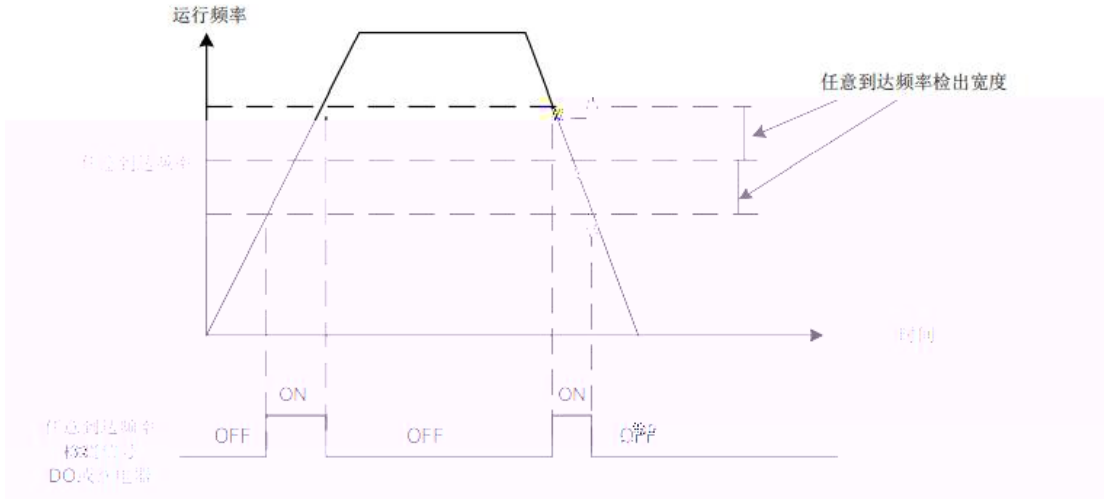

			\$
D&%' (&		\$	
		%	
D&%' ('			\$
		\$	D&%' ((
		%	
		&	5=%
		,	
		%\$ \$i	D&%' ((
D&%' ((\$" \$A] b
			\$" \$A] b *) \$" \$A] b

D&%' (&

8C CB

\$

D&' " &\$

D&%' (' D&%' ((

D&%" *%			%
		\$	
		%	

9\$(\$

+ " %%

D%

5=%

%

D% " ' (

, "%

	9\$\$%	% & , () * +	% & , () * +
	9\$\$'	% & , () *	% & , () *
	9\$\$()	% & , ()	% & , ()
	9\$\$,	%	%
	9\$%)	% D\$+" \$% & ,	% & ,
	9\$%)	% 8= & =C	% &
	9\$%	% &	% &
99DFCA	9\$&%	% 99DFCA	%

% (



	9\$&&	%		%
		&		&
	9\$&*	%		%
		%	8=	
%	9\$&+	&	%	%
		&	=C	&
		%	%	
	9\$&	&	&	%
&		&	=C	&
			&	

	9\$*%	% D\$, " ((% D\$, " ((\$
	9%\$\$	% & , (% & , (
	9%\$%	% & , (% & , (
	9%\$&	% &	% &
	9%\$)	% & , () *	% & , () *
	9%\$,	% &	% &
	9%/\$	% & , () * + J#: ,	% & , () * + J#: ,
	9%/%	%&	% &
	9%/%&	%	%

9%% %
& .
(%
& d

, " &

	%		%	
	&		&	
	'		'	' (
	((r*	
)			
	*			
	%		%	' (
; =X9	&		&r)	
	'			
	(
)			
	%		%	
9%&	&		&	
	'		'	
	(
)			
	*			
	%		%	
; =X9	&		&	
	'			
	(
)			
	*			
	%		%	D\$, " %
9%&\$	&		&	
	'		'	
	(
)			
	*			
	%		%	
	&		&	
	'		'	
	((
)		%	D'
	*		&	
8=	'	DK Ž&(J	'	DK Ž&(J
	((
)			
	*			
	%		%	
	&		&	
	'		'	
	(
)			
	*			
	%		%	
	&		&	
	'		'	
	(
)			
	*			
	%		%	
9ff%+	&		&	
	'		'	&(J
	(
)			
	*			
	%		%	
	&		&	
	'		'	
	(
)			
	*			
	%		%	
	&		&	
	'		'	
	(
)			
	*			
	%		%	
	&		&	
	'		'	
	(
)			
	*			
	%		%	
	&		&	
	'		'	
	(
)			
	*			
	%		%	
	&		&	
	'		'	
	(
)			
	*			
	%		%	
	&		&	
	'		'	
	(
)			
	*			
	%		%	
	&		&	
	'		'	
	(
)			
	*			
	%		%	
	&		&	
	'		'	
	(
)			
	*			
	%		%	
	&		&	
	'		'	
	(
)			
	*			
	%		%	
	&		&	
	'		'	
	(
)			
	*			
	%		%	
	&		&	
	'		'	
	(
)			
	*			
	%		%	
	&		&	
	'		'	
	(
)			
	*			
	%		%	
	&		&	
	'		'	
	(
)			
	*			
	%		%	
	&		&	
	'		'	
	(
)			
	*			
	%		%	
	&		&	
	'		'	
	(
)			
	*			
	%		%	
	&		&	
	'		'	
	(
)			
	*			
	%		%	
	&		&	
	'		'	
	(
)			
	*			
	%		%	
	&		&	
	'		'	
	(
)			
	*			
	%		%	
	&		&	
	'		'	
	(
)			
	*			
	%		%	
	&		&	
	'		'	
	(
)			
	*			
	%		%	
	&		&	
	'		'	
	(
)			
	*			
	%		%	
	&		&	
	'		'	
	(
)			
	*			
	%		%	
	&		&	
	'		'	
	(
)			
	*			
	%		%	
	&		&	
	'		'	
	(
)			
	*			
	%		%	
	&		&	
	'		'	
	(
)			
	*			
	%		%	
	&		&	
	'		'	
	(
)			
	*			
	%		%	
	&		&	
	'		'	
	(
)			
	*			
	%		%	
	&		&	
	'		'	
	(
)			
	*			
	%		%	
	&		&	
	'		'	
	(
)			
	*			
	%		%	
	&		&	
	'		'	
	(
)			
	*			
	%		%	
	&		&	
	'		'	
	(
)			
	*			
	%		%	
	&		&	
	'		'	
	(
)			
	*			
	%		%	
	&		&	
	'		'	
	(
)			
	*			
	%		%	
	&		&	
	'		'	
	(
)			
	*			
	%		%	
	&		&	
	'		'	
	(
)			
	*			
	%		%	
	&		&	
	'		'	
	(
)			
	*			
	%		%	
	&		&	
	'		'	
	(
)			
	*			
	%		%	
	&		&	
	'		'	
	(
)			
	*			
	%		%	
	&		&	
	'		'	
	(
)			
	*			
	%		%	
	&		&	
	'		'	
	(
)			
	*			
	%		%	
	&		&	
	'		'	
	(
)			
	*			
	%		%	
	&		&	
	'		'	
	(
)			
	*			
	%		%	
	&		&	
	'		'	
	(
)			
	*			
	%		%	
	&		&	
	'		'	
	(
)			
	*			
	%		%	
	&		&	
	'		'	
	(
)			
	*			
	%		%	
	&		&	
	'		'	
	(
)			
	*			
	%		%	
	&		&	
	'		'	
	(
)			
	*			
	%		%	
	&		&	
	'		'	
	(
)			
	*			
	%		%	
	&		&	
	'		'	
	(
)			
	*			
	%		%	
	&		&	
	'		'	
	(
)			
	*			
	%		%	
	&		&	
	'		'	
	(
)			
	*			
	%		%	

-

%

&

'

(



5 AC86l G

5" % AC86l G

AC86l G

%AC86l G

D%(" \$\$

\$ AcXVi g

\$

% DB

&

AC86l G

\$ ' \$\$6DG

% *\$\$6DG

& %&\$\$6DG

' &(\$\$6DG

((, \$\$6DG

) - *\$\$6DG

*

D%(" \$%

88 DC

2

88 28

D 88C

~

A&88a

//

kkk" [XYhYWVta

ON

%	=8	% r &))
&		,
,	OAG6Q	
(O@G6Q	
)	OAG6Q	
*	O@G6Q	OB2
+	7F7 O@G6Q	7F7
,	7F7 OAG6Q	

#

	' ")
	% & (+ \$
	\$ \$*
<	# #
@	
<	
@	
<	
@	
7F7@	7F7%
7F7<	
	' ")

5" &
5" &" %

D\$)			D\$*			D\$+	
D\$) " \$\$: (\$8<		D\$*" \$\$:) \$* <		D\$+" \$\$: - \$\$ <
D\$) " \$%	: (\$9<		D\$*" \$%	:) \$+ <		D\$+" \$%	: - \$% <
D\$) " \$\$&	: (\$: <		D\$*" \$\$&	:) \$, <		D\$+" \$\$&	: - \$\$& <
D\$) " \$'	: (%\$ <		D\$*" \$'	:) \$- <		D\$+" \$'	: - \$' <
D\$) " \$(: (%\$ <		D\$*" \$(:) \$5 <		D\$+" \$(: - \$(<
D\$) " \$)	: (%\$ <		D\$*" \$)	:) \$6 <		D\$+" \$)	: - \$) <
D\$) " \$*	: (% <		D\$*" \$*	:) \$7 <		D\$+" \$*	: - \$* <
D\$) " \$+	: (% <		D\$*" \$+	:) \$8 <		D\$+" \$+	: - \$+ <
D\$) " \$,	: (% <		D\$*" \$,	:) \$9 <		D\$+" \$,	: - \$, <
D\$) " \$-	: (% <		D\$*" \$-	:) \$: <		D\$+" \$-	: - \$- <
D\$) " %\$: (% <		D\$*" %\$:) %\$ <		D\$+" %\$: - %\$ <
D\$) " %%	: (% <		D\$-			D\$+" %%	: - % <
D\$) " %&	: (% <		D\$- " \$\$: 6\$\$ <		D\$+" %&	: - % & <
D\$) " %	: (% <		D\$- " \$%	: 6\$% <		D\$+" %	: - % <
D\$) " %&	: (% <		D\$- " \$\$&	: 6\$\$& <		D\$+" %&	: - % & <
D\$) " %'	: (% <		D\$- " \$'	: 6\$' <		D\$+" %'	: - %' <
D\$) " %(\$: (% <		D\$- " \$(: 6\$(<		D\$+" %*	: - %\$ <
D\$) " %)(\$: (% <		D\$- " \$)	: 6\$) <		D\$+" %+	: - %\$ <
D\$) " %*	: (% <		D\$- " \$*	: 6\$* <		D\$+" %	: - % & <
D\$) " %+(\$: (% <		D\$- " \$+	: 6\$+ <		D\$+" %	: - % <
D\$) " %&(\$: (% <		D\$- " \$,	: 6\$, <		D\$+" %&	: - % & <
D\$) " %&(\$: (% <		D\$- " \$-	: 6\$- <		D\$+" %&	: - % & <
D\$,			D\$- " %\$: 7\$\$ <		D\$+" %&	: - %* <
D\$, " \$\$: \$\$\$ <		D\$- " %%	: 7\$% <		D\$+" %'	: - % & <
D\$, " \$%	: \$\$\$% <		D\$- " %&	: 7\$& <		D\$+" %(\$: - % & <
D\$, " \$\$&	: \$\$\$& <		D\$- " %	: 7\$' <		D\$+" %)	: - % & <
D\$, " \$'	: \$\$\$' <		D\$- " %&	: 7\$(<		D\$+" %*	: - %\$ <
D\$, " \$(: \$\$\$(<		D\$- " %'	: 7\$) <		D\$+" %+(\$: - %\$ <
D\$, " \$)	: \$\$\$)<		D\$- " %*	: 7\$* <		D\$+" %&	: - %\$ <
D\$, " \$*	: \$\$\$* <		D\$- " %+(\$: 7\$+ <		D\$+" %&	: - %\$ <
D\$, " \$+	: \$\$\$+ <		D\$- " %	: 7\$, <		D\$+" ' \$: - %\$ <
D\$, " \$,	: \$\$\$, <		D\$- " %	: 7\$- <		D\$+" ' %	: - % & <
D\$, " \$-	: \$\$\$- <		D\$- " %&	: 7\$5 <		D\$+" ' &	: - %\$ & <
D\$, " %\$: \$\$\$5 <		D\$- " %&	: 7\$6 <		D\$+" ' ' &	: - %\$ & <
D\$, " %%	: \$\$\$6 <		D\$- " %&	: 7\$7 <		D\$+" ' (: - %\$ & <
D\$, " %&	: \$\$\$7 <		D\$- " %'	: 7\$8 <		D\$+" ')	: - %\$ & <
D\$, " %	: \$\$\$8 <		D\$- " %(\$: 7\$9 <		D\$+" ' *	: - %\$ & <
D\$, " %&	: \$\$\$9 <		D\$- " %)	: 7\$: <		D\$+" ' +	: - %\$ & <
D\$, " %'	: \$\$\$: <		D\$- " %*	: 7\$% <		D\$+" ' ,	: - %\$ & <
D\$, " %(\$: \$\$\$\$ <		D\$- " %+(\$: 7\$% <		D\$+" ' -	: - %\$ & <
D\$, " %&(\$: \$\$\$& <		D\$- " %&	: 7\$% <		D\$+" (\$: - %\$ & <
D\$, " %	: \$\$\$% <		D\$- " %&	: 7% <		D\$+" (%	: - %\$ & <
D\$, " %	: \$\$\$ <		D\$- " ' \$: 7% <		D\$+" (&	: - %\$ & <
D\$, " %&	: \$\$\$ <		D\$- " ' %	: 7% <		D\$+" (' &	: - %\$ & <

D\$, " &% : \$%) <	D\$- "' & : 7%* <	D\$+" ((: - &7<
D\$, " && : \$%* <	D\$- "' ' : 7%+<	D\$+" () : - &8<
D\$, " &' : \$%+<	D\$- "' (: 7% <	D\$+" (* : - &9<
D\$, " &(: \$% <	D\$- "') : 7% <	D\$+" (+ : - & <
D\$, " &) : \$% <	D\$- "' * : 7%5<	D\$+" (, : - ' \$<
D\$, " &* : \$%5<	D\$- "' + : 7%6<	D\$+" (- : - ' %<
D\$, " &+ : \$%6<	D\$- "' , : 7%7<	D\$+") \$: - ' &<
D\$, " & : *\$ \$<	D\$- "' - : 7%8<	D\$+") % : - ' ' <
D\$, " &- : *\$ %<	D\$- " (\$: 7%9<	D\$+") & : - ' (<
D\$, "' \$: *\$ &<	D\$- " (% : 7% <	D\$+") ' : - ') <
D\$, "' % : *\$ ' <	D\$- " (& : 7&\$<	D\$+") (: - ' * <
D\$, "' & : *\$ (<	D\$- " (' : 7&%<	D\$+")) : - ' + <
D\$, "' ' : *\$) <	D\$- " ((: 7&&<	D\$+") * : - ' , <
D\$, "' (: *\$ * <	D\$- " () : 7&' <	D\$+") + : - ' - <
D\$, "') : *\$ + <	D\$- " (* : 7&(<	D\$+") , : - ' 5<
D\$, "' * : *\$, <	D\$- " (+ : 7&) <	D\$+") - : - ' 6<
D\$, "' + : *\$ - <	D\$- " (, : 7&* <	D\$+") *\$: - ' 7<
D\$, "' , : *\$ \$ <	D\$- " (- : 7&+ <	D\$+") *% : - ' 8<
D\$, "' - : *\$ 6<	D\$- ") \$: 7& <	D\$+") * & : - ' 9<
D\$, " (\$: *\$ 7<	D\$- ") % : 7&- <	D\$+") ' : - ' : <
D\$, " (% : *\$ 8<	D\$- ") & : 7&5<	D\$+") * (: - (\$ <
D\$, " (& : *\$ 9<	D\$- ") ' : 7&6<	D\$+") *) : - (% <
D\$, " (' : *\$: <	D\$- ") (: 7&7<	D\$+") * * : - (& <
D\$, " ((: *\$ % <	D\$- ")) : 7&8<	D\$+") * + : - (' <
D\$, " () : *\$ % <	D\$- ") * : 7&9<	D\$+") * , : - ((<
D\$, " (* : *\$ % <	D\$- ") + : 7& <	D\$+") * : - () <
D\$, " (+ : *\$ % <	D\$- ") , : 7' \$ <	D\$+") + \$: - (* <
D\$, " (, : *\$ % <	D\$- ") - : 7' % <	D\$+") + % : - (+ <
D\$, " (- : *\$ % <	D\$- ") * \$: 7' & <	D\$+") + & : - (, <
	D\$- ") * % : 7' ' <	D\$+") + ' : - (- <
		D\$+") + (: - (5 <
		D\$+") +) : - (6 <

	D%&	D%&
	D%&' \$\$: &\$ \$<	D%&' \$\$: &\$ \$<
	D%&' \$% : &\$ %<	D%&' \$% : &\$ %<
	D%&' \$\$: &\$ \$<	D%&' \$\$: &\$ \$<
	D%&' \$' : &\$ ' <	D%&' \$' : &\$ ' <
	D%&' \$(: &\$ (<	D%&' \$(: &\$ (<
	D%&' \$) : &\$) <	D%&' \$) : &\$) <
	D%&' \$* : &\$ * <	D%&' \$* : &\$ * <
	D%&' \$+ : &\$ + <	D%&' \$+ : &\$ + <
D%\$	D%&' \$: &\$, <	D%&' \$, : &\$, <
D%\$" \$\$: ' \$ \$<	D%&' \$- : &\$ - <	D%&' \$- : &\$ - <
D%\$" \$% : ' \$ %<	D%&' \$% : &\$ % <	D%&' \$% : &\$ % <

D%\$" \$&	: ' \$&<	D%%" %%	5&\$6<	D%&" %%	: &\$6<
D%\$" '\$: ' '\$ <	rD%%" %)	r5&\$: <	D%&" %&	: &\$7<
D%\$" \$(: ' \$(<	D%%" %*	5&%"\$<	D%&" %	: &\$8<
D%\$" \$)	: ' \$) <	D%%" %+	5&%"%<	D%&" %)	: &\$9<
D%\$" \$*	: ' \$* <	D%%" %	5&%"&<	D%&" %)	: &\$: <
D%\$" \$+	: ' \$+ <	D%%" %&	5&%"(<	D%&" %*	: &%"\$<
D%\$" \$,	: ' \$, <	D%%" %&	5&%") <	D%&" %+	: &%"&<
D%\$" \$-	: ' \$- <	D%%" &&	5&%"* <	D%&" %	: &%"&<
D%\$" %\$: ' %\$ <	rD%%" &*	r5&%"5<	D%&" %	: &%" <
D%\$" %%	: ' %6<	D%%" &+	5&%"6<	D%&" %&	: &%"(<
D%\$" %&	: ' %7<	D%%" &	5&%"7<	D%&" %&	: &%") <
D%\$" %	: ' %8<	D%%" &-	5&%"8<	D%&" %&	: &%"* <
D%\$" %)	: ' %9<	D%%" ' \$	5&%"9<	D%&" %&	: &%"& <
D%\$" %)	: ' %: <	D%%" ' %	5&%" <	D%&" %&	: &%"& <
D%\$" %*	: ' %\$ <	D%%" ' &	5&%"\$<	D%&" %)	: &%" <
D%\$" %+	: ' %%<	D%%" ' (5&%"%<	D%&" %*	: &%"5<
D%\$" %	: ' %&<	D%%" ')	5&%"' <	D%&" %+	: &%"6<
D%\$" %	: ' % <	D%%" ' *	5&%"(<	D%&" %	: &%"7<
D%\$" %&	: ' % (<	D%%" ' +	5&%") <	D%&" %&	: &%"8<
D%\$" %&	: ' %* <	D%	D%	D%&" ' \$: &%"9<
D%\$" %&	: ' %+ <	D% " \$\$	5&%"* <	D%&" ' %	: &%" <
D%\$" %&	: ' % <	D% " %%	5&%"&+ <	D%&" ' &	: &%"\$ <
D%\$" %&	: ' % <	D% " \$&	5&%"& <	D%&" ' ')	: &%"% <
D%\$" %&	: ' % <	D% " '\$	5&%"&- <	D%&" ' (: &%"& <
D%\$" %*	: ' %5 <	D% " \$(5&%"5 <	D%&" ')	: &%" <
D%\$" %+	: ' %6 <	D% " \$)	5&%"6 <	D%&" ' *	: &%"(<
D%\$" %&	: ' %7 <	D% " \$*	5&%"7 <	D%&" ' " %	

D%\$" ()	: %\$6<		D% " &	5&' 8<		D%\$ " \$\$: 5\$5<
r D%\$" (-	r: %\$<						
D%\$") \$: %\$<		D% " &(5&' 9<		D%\$ " \$%	: 5\$%<
D%\$") %	: %\$<		D% " &)	5&' : <		D%\$ " \$&	: 5\$&<
D%\$") &	: %\$<		D% " &*	5&' (\$<		D%\$ " '\$: 5\$' <
D%\$") '	: %\$ <		D% " &+	5&' (%<		D%\$ " \$(: 5\$(<
D%\$") (: %\$ <		D% " &	5&' (&<		D%\$ " \$)	: 5\$) <
D%\$"))	: %\$ <		D% " &-	5&' (' <		D%\$ " \$*	: 5\$* <
D%\$") *	: %\$* <		D% " ' \$	5&' ((<		D%\$ " \$+	: 5\$+<
r D%\$" * \$	r: %\$5<						
D%\$" * %	: %\$6<		D% " ' %	5&' (<		D%\$ " \$,	: 5\$, <
D%\$" * &	: %\$7<		D% " ' &	5&' (* <		D%\$ " \$-	: 5\$- <
D%\$" * '	: %\$8<		D% " ' '	5&' (+ <		D%\$ " %\$: 5\$5<
D%\$" * (: %\$9<		D% " ' (5&' (, <		D%\$ " %%	: 5\$6<
D%\$" *)	: %\$ <		D% " ')	5&' (- <		D%\$ " %&	: 5\$7<
D%\$" * *	: %\$&<		D% " ' *	5&' (5 <		D%\$ " %	: 5\$8<
D%\$" * +	: %\$%<		D% " ' +	5&' (6 <		D%\$ " %'	: 5\$9<
D%\$" * ,	: %\$&<		D% " ' ,	5&' (7 <		D%\$ " %)	: 5\$, <
D%\$" * -	: %\$' <		D% " ' -	5&' (8 <		D%\$ " %*	: 5\$&<
D%\$" + \$: %\$ (<		D% " (\$	5&' (9 <		D%\$ " %+	: 5\$%<
D%\$" + %	: %\$) <		D% " (%	5&' (: <		D%\$ " %	: 5\$&<
	D%('		D% " (&	5&' (\$ <		D%\$ " %	: 5\$ <
D%\$ " \$\$: \$7<		D% " ('	5&' (%<		D%\$ " &\$: 5\$(<
D%\$ " \$%	: 8\$\$<		D% " ((5&' (&<		D%\$ " &%	: 5\$) <
D%\$ " \$&	: 8\$%<		D% " ()	5&' (' <		D%\$ " &&	: 5\$* <
D%\$ " '\$: 8\$&<		D% " (*	5&' (<		D%\$ " &'	: 5\$+ <
D%\$ " \$(: 8\$' <		D% " (+	5&') <		D%\$ " &(&	: 5\$ <
D%\$ " \$)	: 8\$(<		D% " (,	5&') * <		D%\$ " &)	: 5\$ <
D%\$ " \$*	: 8\$) <		D% " (-	5&') + <		D%\$ " &*	: 5\$5 <
D%\$ " \$+	: 8\$* <		D% ") \$	5&' , <		D%\$ " &+	: 5\$6 <
D%\$ " \$,	: 8\$+ <		D% ") %	5&' - <		D%\$ " &	: 5\$7 <
D%\$ " \$-	: 8\$, <		D% ") &	5&') 5 <			D&%
			D% ") '	5&') 6 <		D&% " \$\$: , \$ <
	D%*			D%*		D&% " \$%	: , \$% <
D%\$ " \$\$	5%\$&<		D% " \$\$	5* \$\$&<		D&% " \$&	: , \$& <
D%\$ " \$%	5%\$%<		D% " \$%	5* \$%&<		D&% " '\$: , '\$ <
D%\$ " \$&	5%\$&<		D% " \$&	5* \$&&<		D&% " \$(: , \$(<
D%\$ " '\$	5%\$' <		D% " '\$	5* \$' <		D&% " \$)	: , \$) <
D%\$ " \$(5%\$(<		D% " \$(5* \$(<		D&% " \$*	: , \$* <
D%\$ " \$)	5%\$) <		D% " \$)	5* \$) <		D&% " \$+	: , \$+ <
D%\$ " \$*	5%\$* <		D% " \$*	5* \$* &<		D&% " \$,	: , \$, <
D%\$ " \$+	5%\$+ <		D% " \$+	5* \$+ &<		D&% " \$-	: , \$- <
D%\$ " \$,	5%\$, <		D% " \$,	5* \$, <		D&% " %\$: , \$5 <
D%\$ " \$-	5%\$- <		D% " \$-	5* \$- <		D&% " %%	: , \$6 <
D%\$ " %\$	5%\$5 <		D% " %\$	5* \$5 &<		D&% " %&	: , \$7 <

D&' fID&' " \$r D&' " &* Ł		D&' fID&' " &r D&' " *' Ł		D&%') +	5) \$\$<
D&' " \$\$	+\$\$\$<	D&' " &+	+\$%6<	D&%') ,	5) \$%<
D&' " \$%	+\$\$\$%<	D&' " &,	+\$%7<	D&%') -	5) \$\$&<
D&' " \$&	+\$\$\$&<	D&' " &-	+\$%8<	D&%' " * \$	5) \$' <
D&' " \$'	+\$\$\$' <	D&' "' \$	+\$%9<	D&%' " * %	5) \$(<
D&' " \$(+\$\$(<	D&' "' %	+\$% <	D&%' " * &	5) \$) <
D&' " \$)	+\$\$() <	D&' "' &	+\$\$\$<	D&%' " *	5) \$* <
D&' " \$*	+\$\$\$* <	D&' "' '	+\$%&<	D&%' " *(5) \$+ <
D&' " \$+	+\$\$\$+ <	D&' "' (+\$\$\$&<	D&%' " *)	5) \$, <
D&' " \$,	+\$\$\$, <	D&' "')	+\$\$' <	D&%' " **	5) \$- <
D&' " \$-	+\$\$\$- <	D&' "' *	+\$\$(<	D&' fID&' " *(r D&' " + (Ł	
D&' " %\$	+\$\$\$5<	D&' "' +	+\$&) <	D&' " *(+\$(\$ <
D&' " %%	+\$\$\$6<	D&' "' ,	+\$&* <	D&' " *)	+\$(% <
D&' " %&	+\$\$\$7<	D&' "' -	+\$&+ <	D&' " **	+\$(& <
D&' " %	+\$\$\$8<	D&' " (\$	+\$& <	D&' " *+	+\$(' <
D&' " %(&	+\$\$\$9<	D&' " (%	+\$&- <	D&' " *,	+\$((<
D&' " %)	+\$\$\$: <	D&' " (&	+\$&5 <	D&' " *-	+\$() <
D&' " %*	+\$\$\$% <	D&' " ('	+\$&6 <	D&' " +\$	+\$(* <
D&' " %+	+\$\$\$% <	D&' " ((+\$&7 <	D&' " +%	+\$(+ <
D&' " %	+\$\$\$% <	D&' " ()	+\$&8 <	D&' " +&	+\$(, <
D&' " %	+\$\$\$% <	D&' " (*	+\$&9 <	D&' " +'	+\$(- <
D&' " &\$	+\$\$\$(& <	D&' " (+ r D&' ") +	+\$& < r +\$' - <	D&' " +(+\$(5 <
D&' " &%	+\$\$\$% <	D&' "),	+\$' 5 <		
D&' " &&	+\$\$\$* <	D&' ")-	+\$' 6 <		
D&' " &'	+\$\$\$+ <	D&' " * \$	+\$' 7 <		
D&' " &(&	+\$\$\$% <	D&' " * %	+\$' 8 <		
D&' " &)	+\$\$\$% <	D&' " * &	+\$' 9 <		
D&' " &*	+\$\$\$% <	D&' " * '	+\$' : <		

5 &' &

fI<9ŁŁ					
%%\$\$\$<	%%\$\$\$\$	%%\$\$\$\$	\$" \$%	% %%\$ " \$! ! %\$\$\$\$! %\$ " \$!	%%\$\$\$\$
				& D\$, " %\$ D%&' %\$ D% " %\$	



5 &"'



f|<9Lk
%\$\$%<
%\$\$&<
%\$\$' <
%\$\$(<
%\$\$)<
%\$\$*<
%\$\$+<
%\$\$, <
%\$\$- <
%\$\$6<
%\$\$8<
%\$\$9<

8=
8C
5=%

\$" \$%<n
\$" %J
%J
\$" \$%B
\$" %_K
\$" %\$i
%
%
\$" \$%J
\$" \$%J
%

GF630N03

1. 02

%
&
,

Ki \Ub ; i] XY HWXbc` c[m 7c" ž@hX"

*

(' \$&&
, *! \$&+! , +- &+&' \$
g\Zk4[XYhYWŴŵa
kkk" [XYhYWŴŵa
(\$\$! \$\$++!) +\$

Wihan Guide Technology Co., Ltd.