

GUIDE

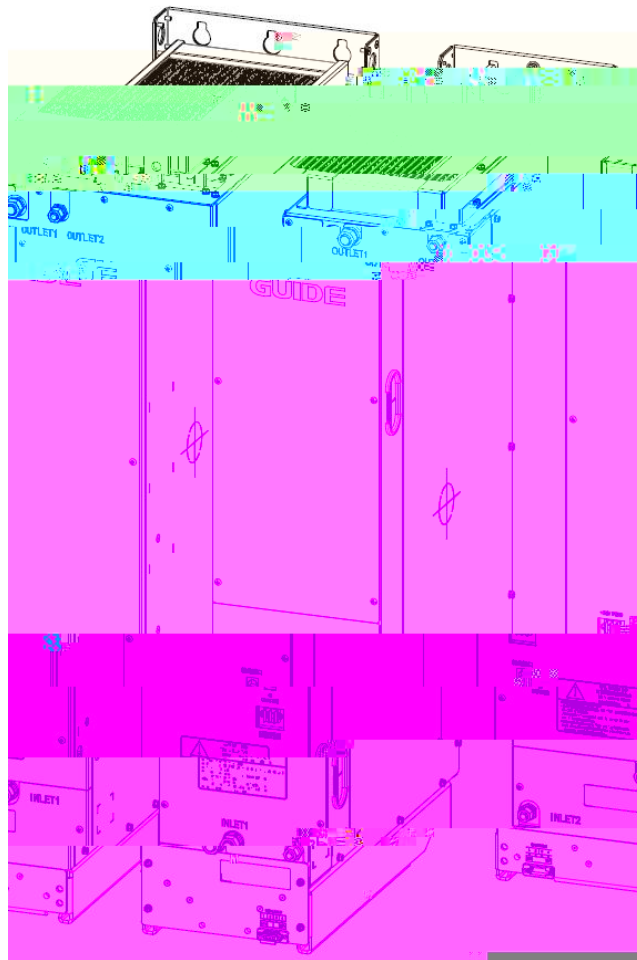

.....	1
.....	5
.....	5
.....	6
.....	6
.....	7
.....	9
.....	14
.....	14
.....	20
.....	21
.....	22
.....	23
.....	23
.....	25
.....	25
.....	30
.....	34
.....	34
.....	35
.....	36
.....	37
.....	37
.....	38
.....	45
.....	46
.....	51
.....	71
.....	77
.....	83
.....	83
.....	85
.....	87
.....	88
.....	90
.....	92



.....	95
.....	98
.....	101
.....	104
.....	105
.....	107
.....	108
.....	110
.....	113
.....	116
.....	119
.....	122
.....	127
.....	132
.....	137



U V W



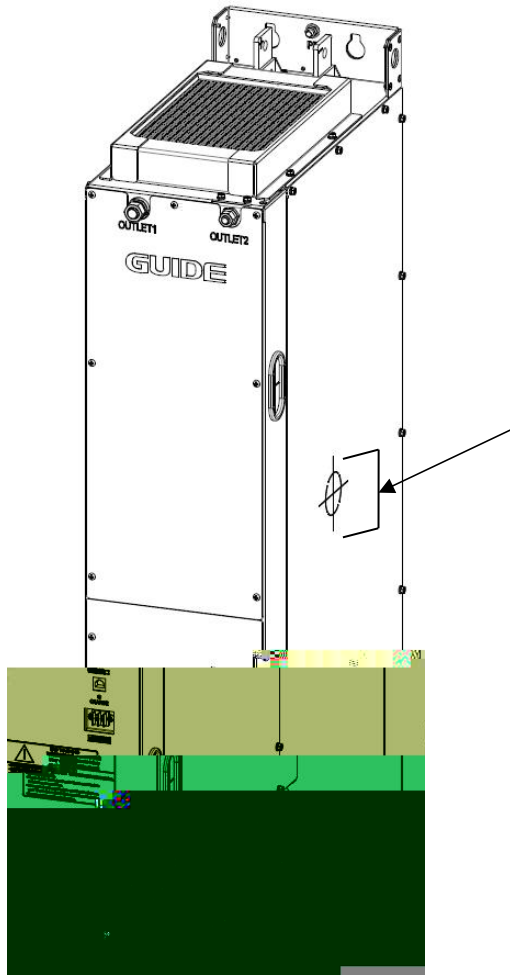



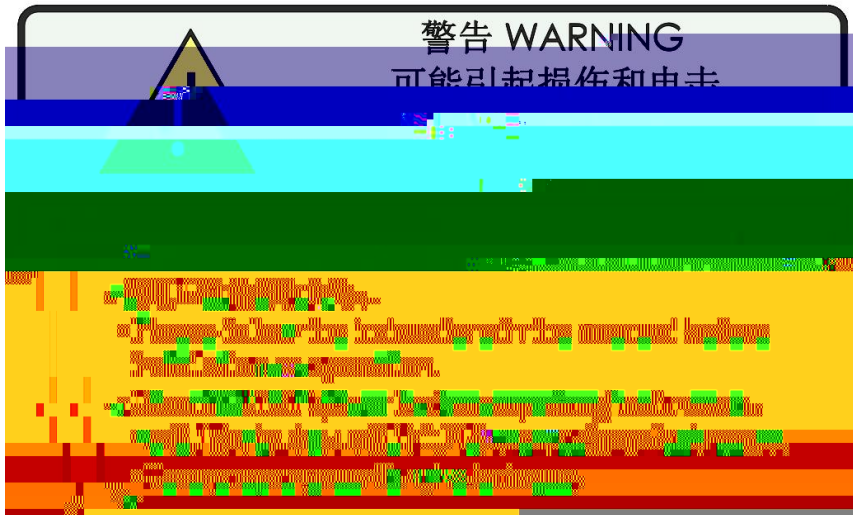

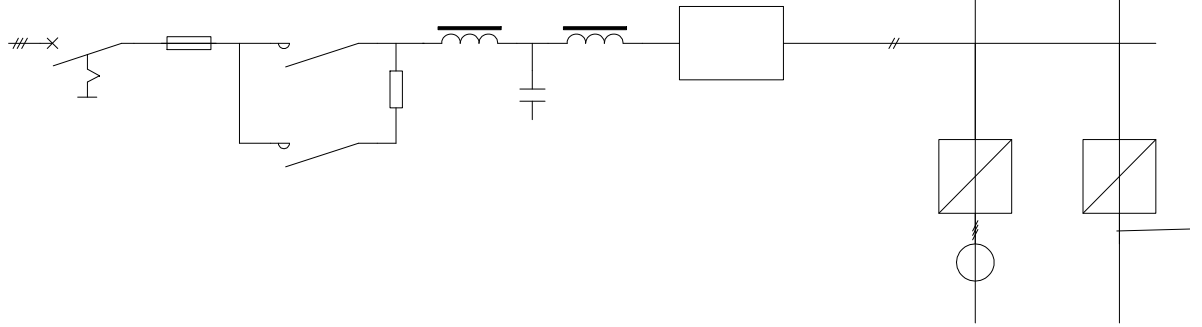

GUIDE





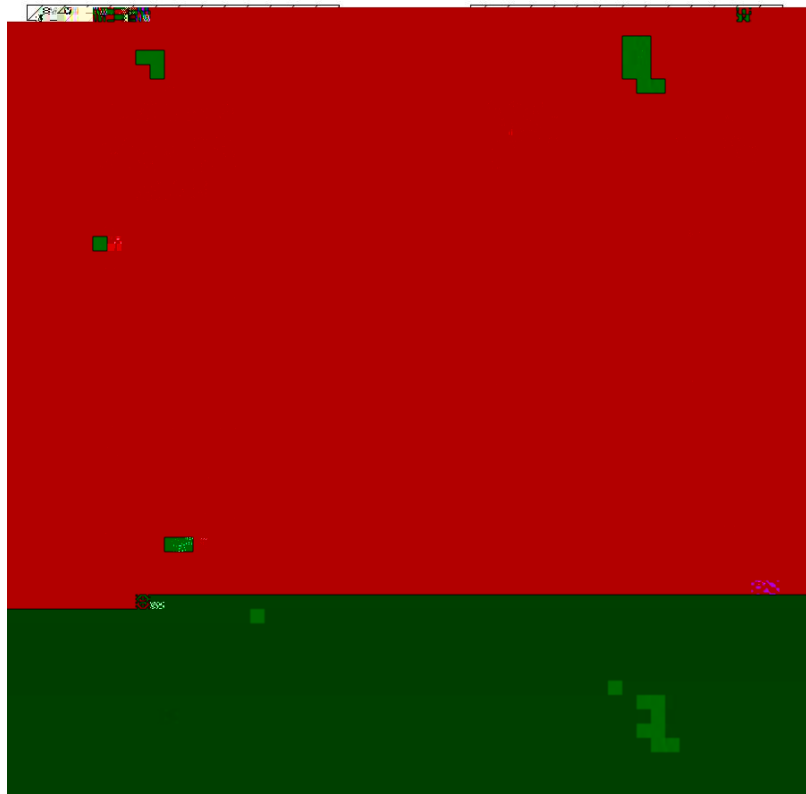

1

2



1

2

3

4

5

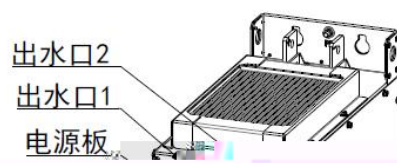

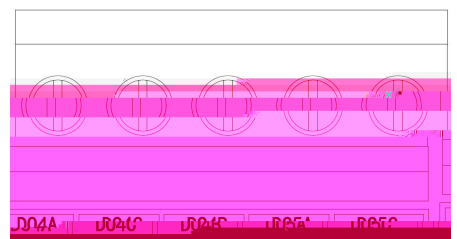
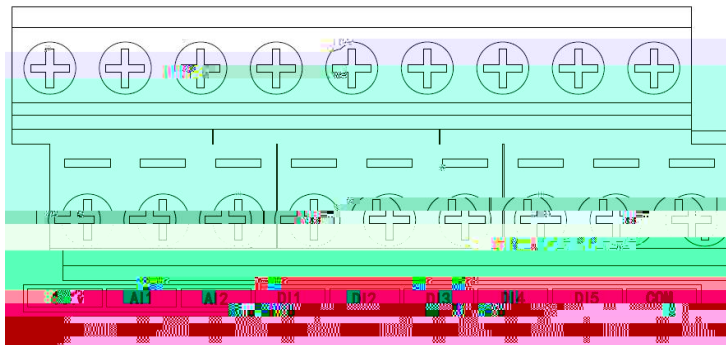
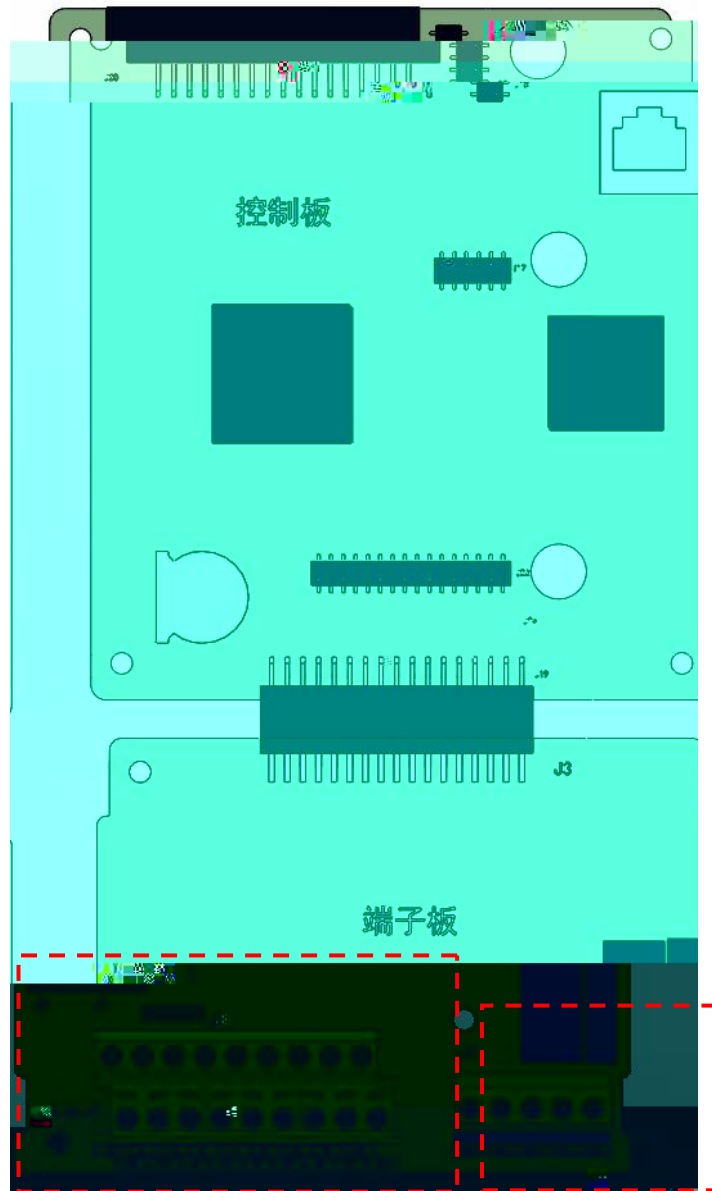

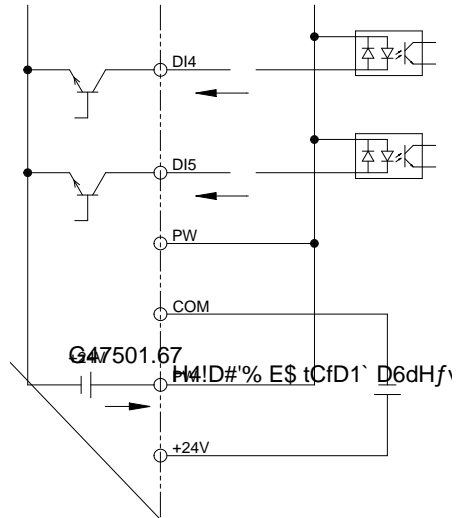
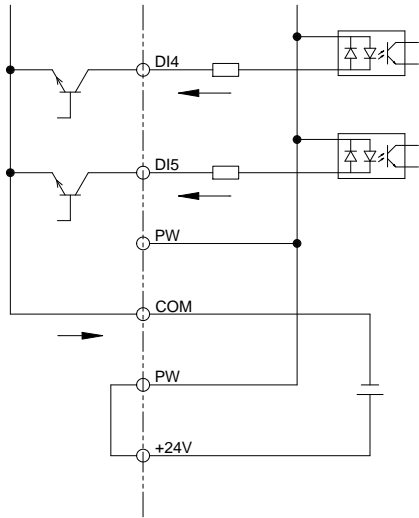

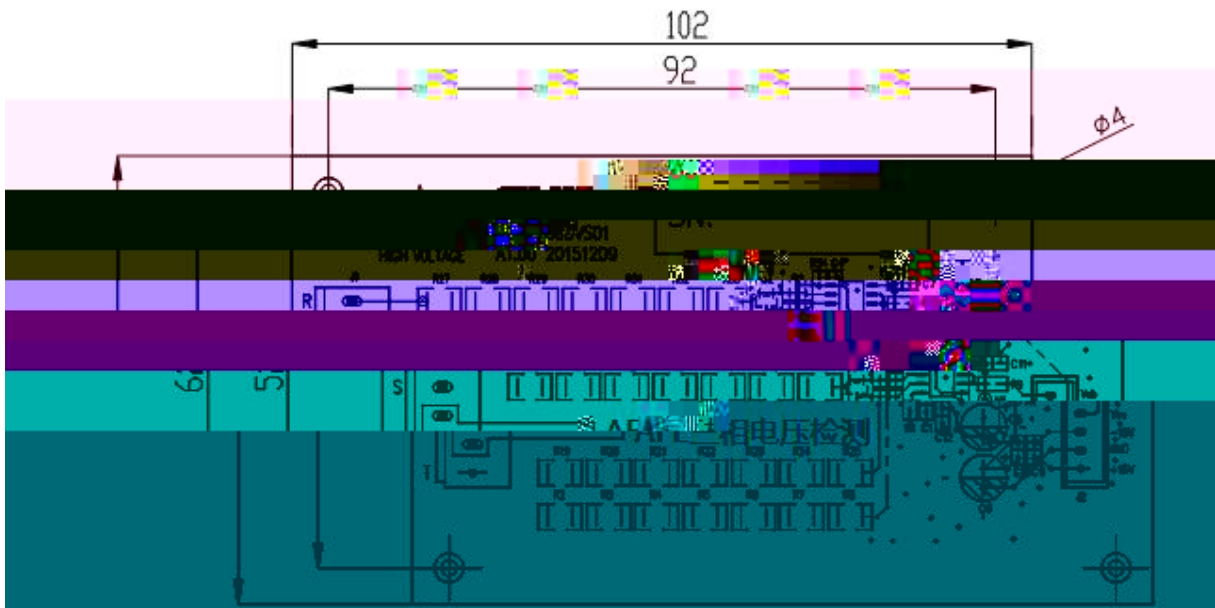

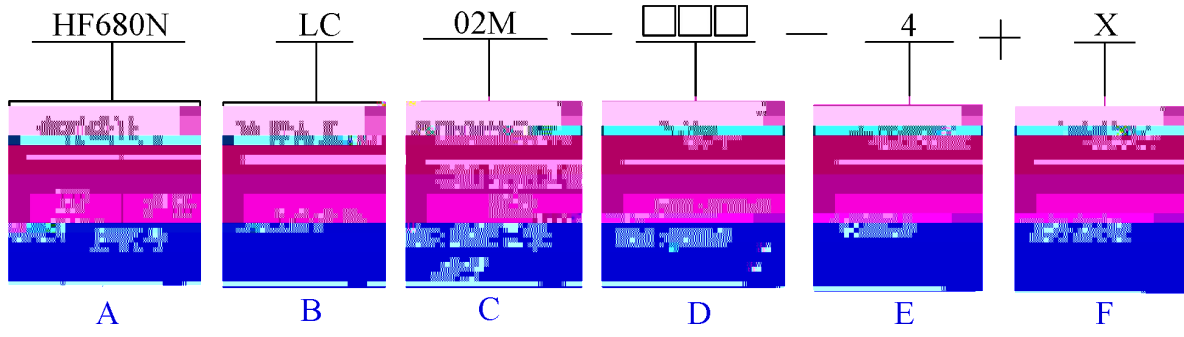

1

LCD

2

AC380V

PCB1500350

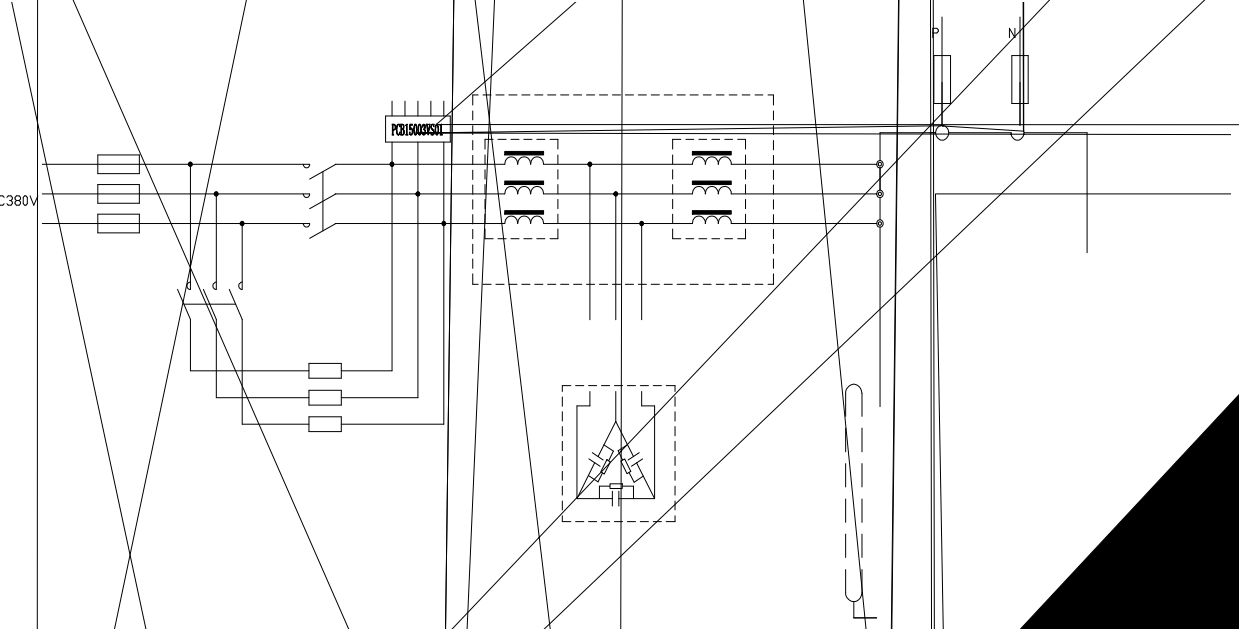

(8)

(9)

(10)

(11)

(12)

(13)

(14)

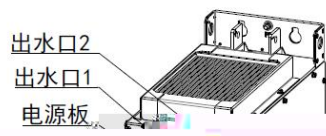

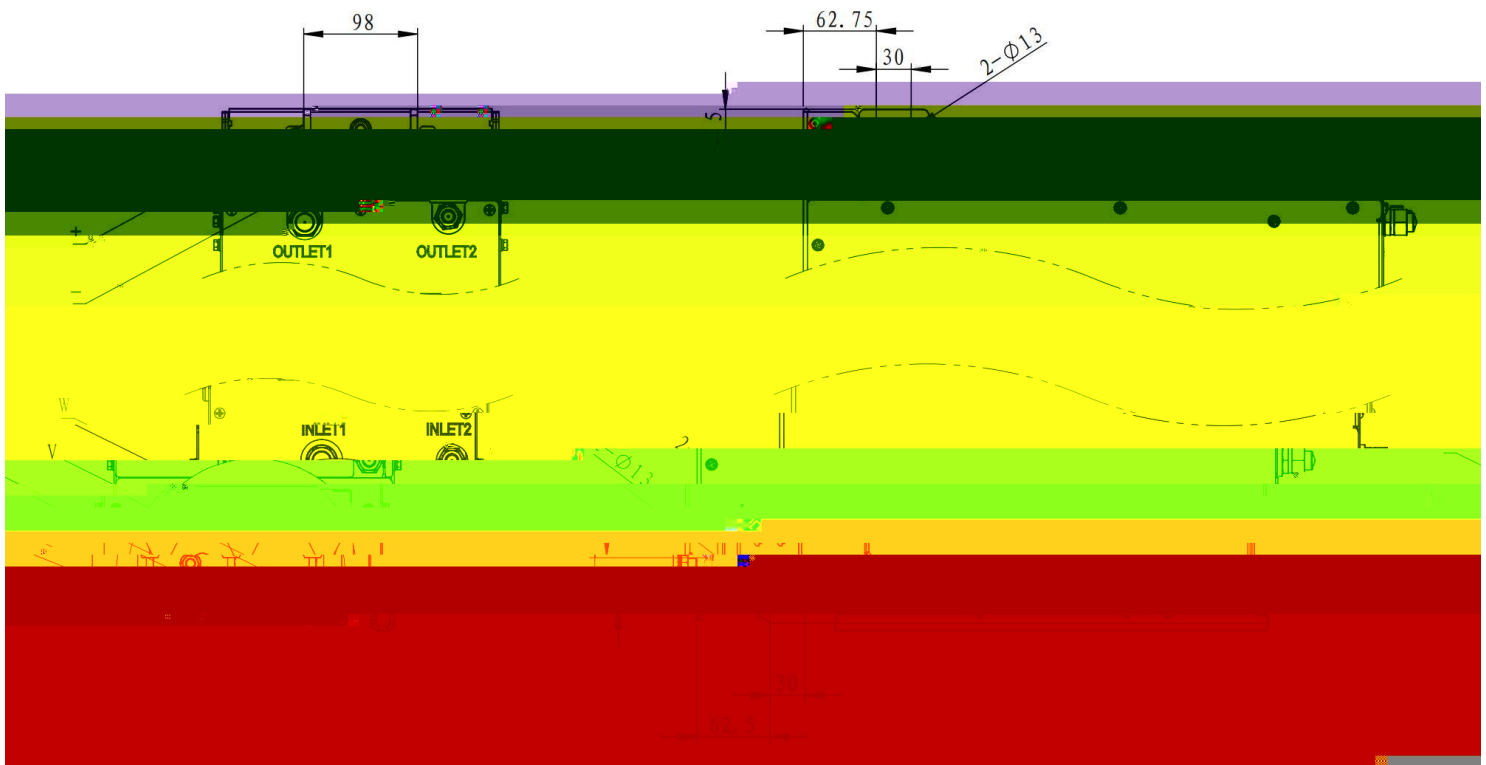

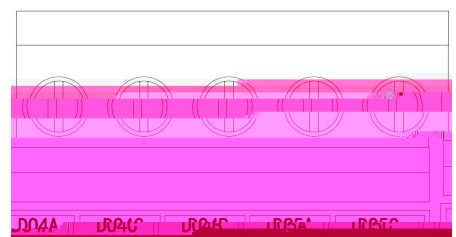
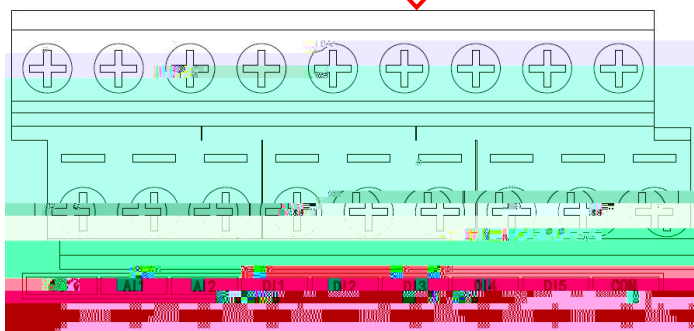
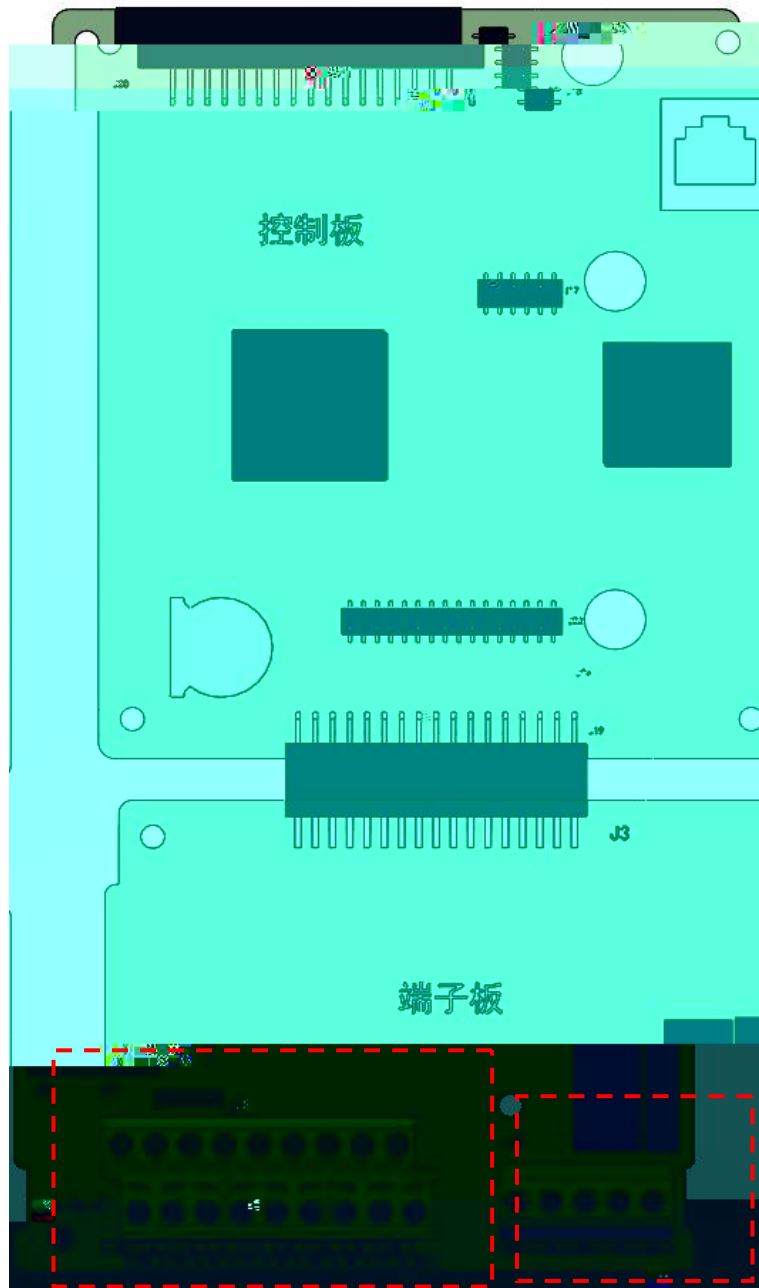



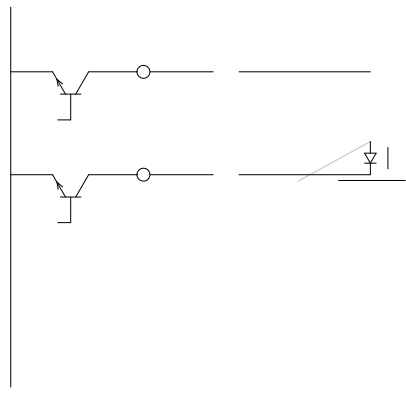
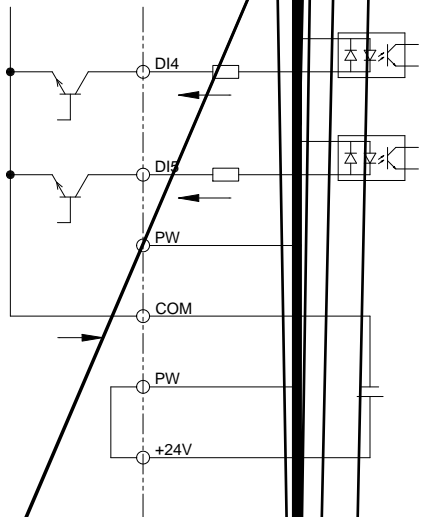

MO

M

M

ie

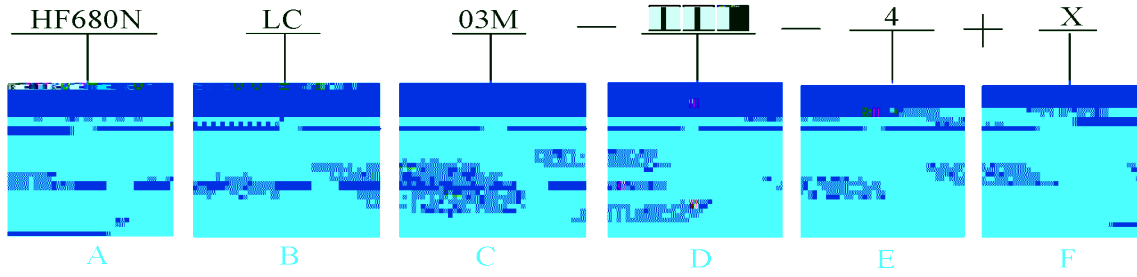

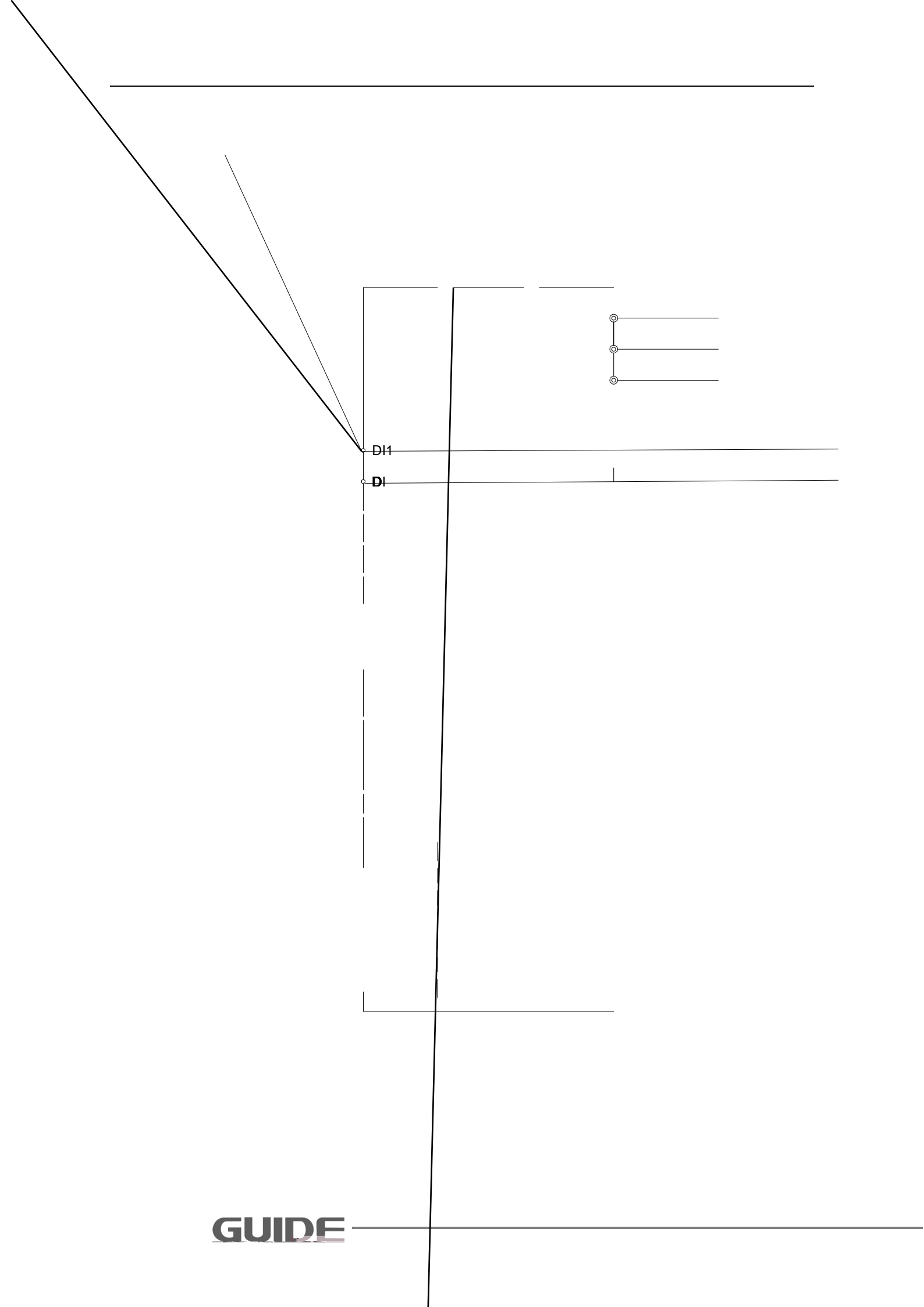

GUIDE

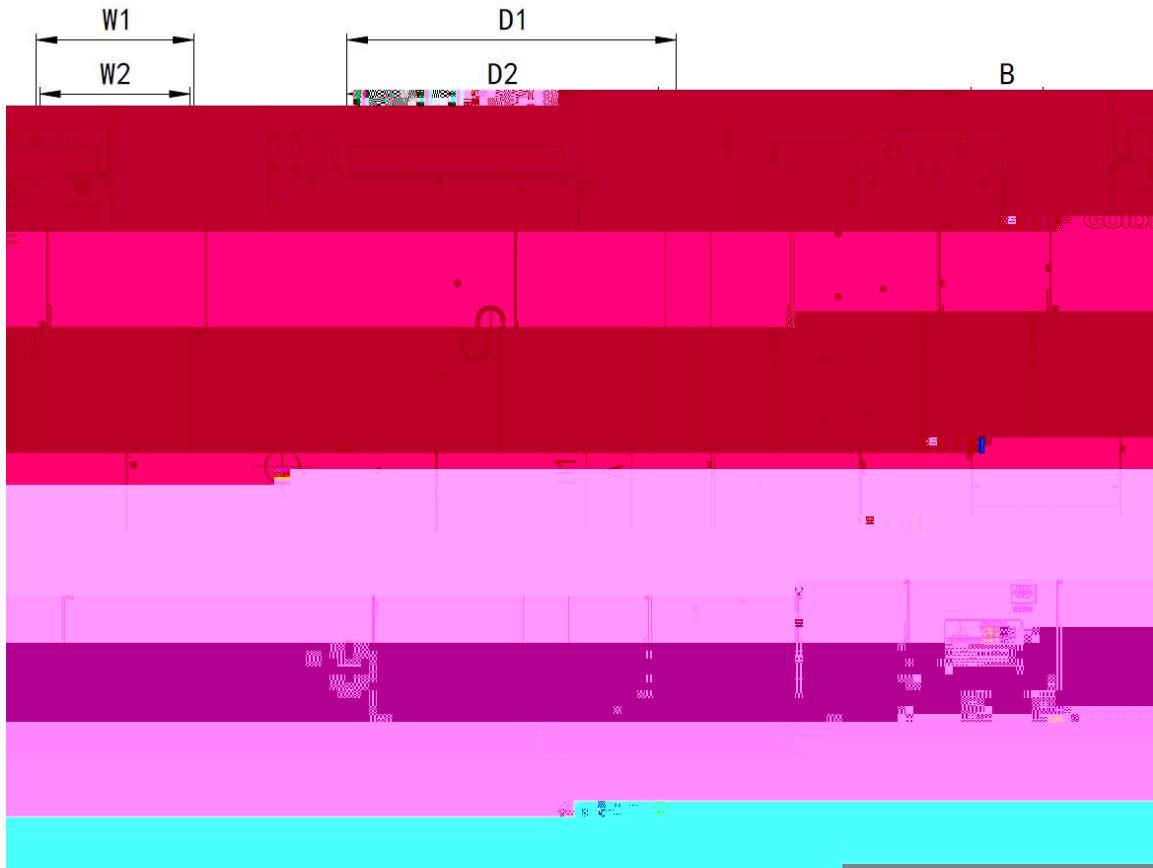



0. 0Hz 117. 6V 0. 0A N|N

电机速度 [Hz]: 0. 0Hz

给定频率 [Hz]: 10. 0Hz

母线电压 : 117. 6V

电机电流 : 0. 0A



--	--	--

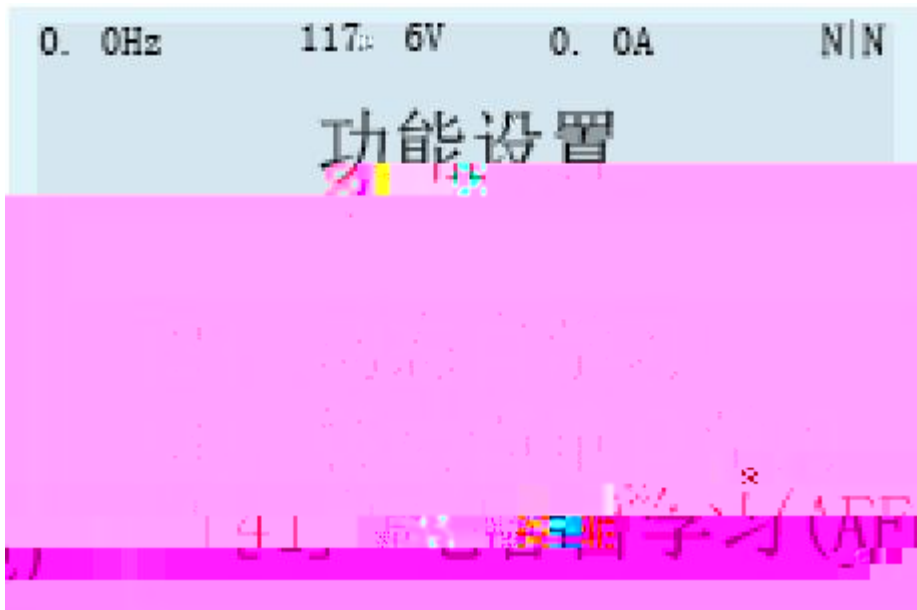

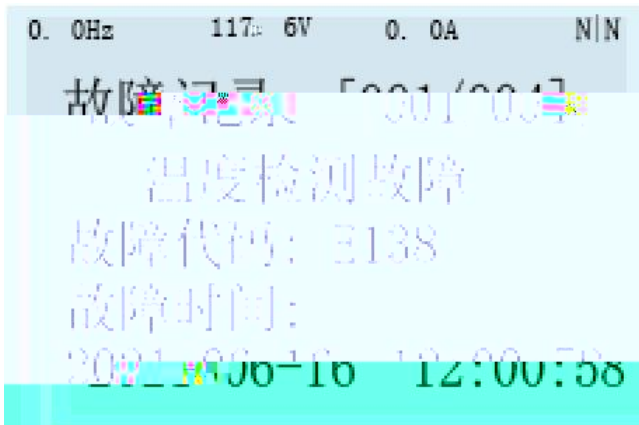



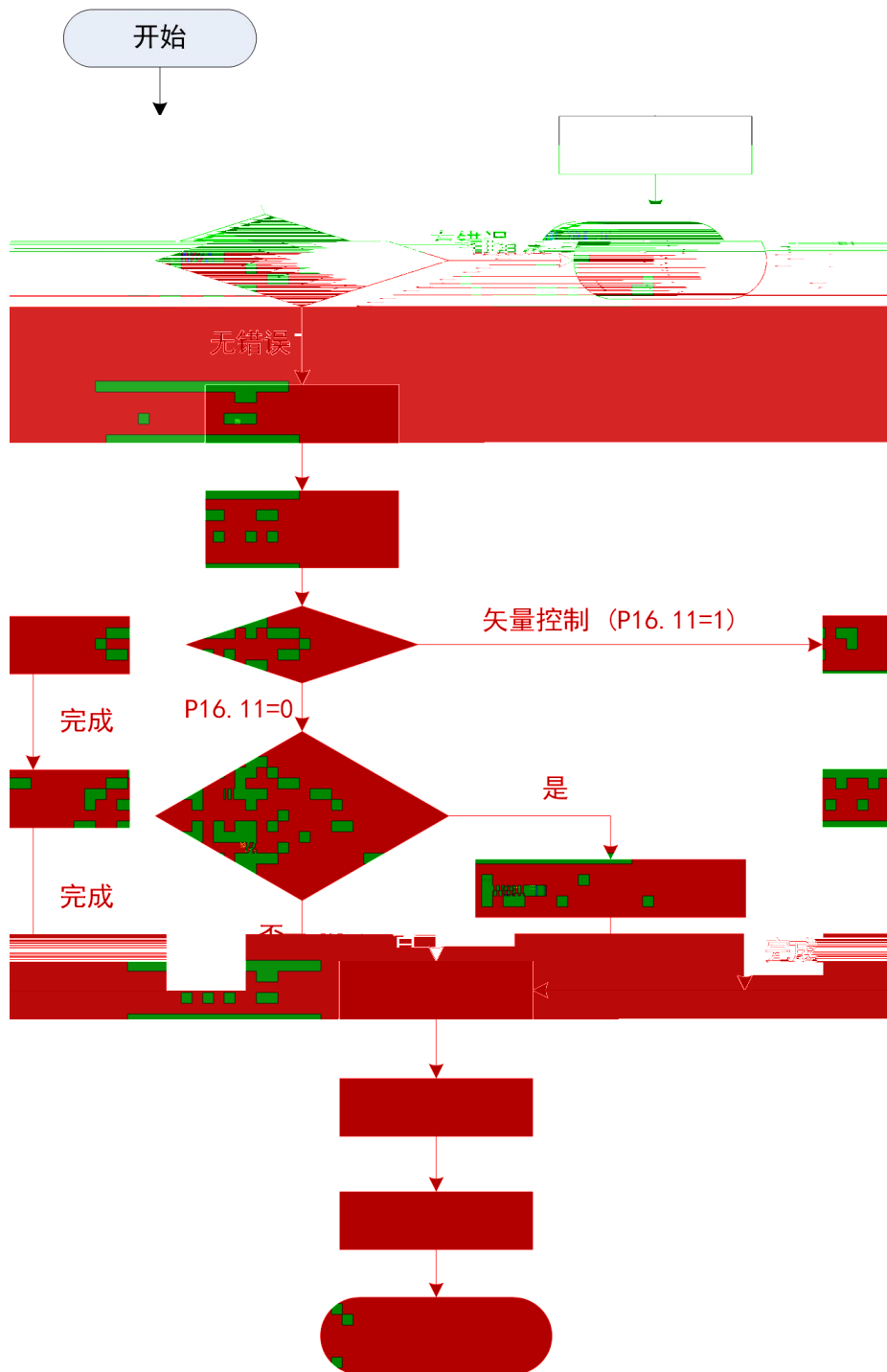

Ä ; AÆ Ð(æ

∇

H

ORANGE
GUIDE





参数	名称	值	单位
100.15	DO 功能本地测试 1	1	
100.16	DO 功能本地测试 2	0	
100.17	DO 功能本地测试 3	0	



F 0;

运行

停止

运行

È



Ã

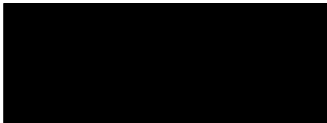

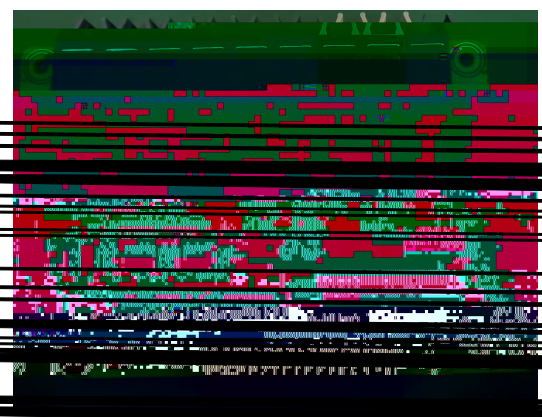
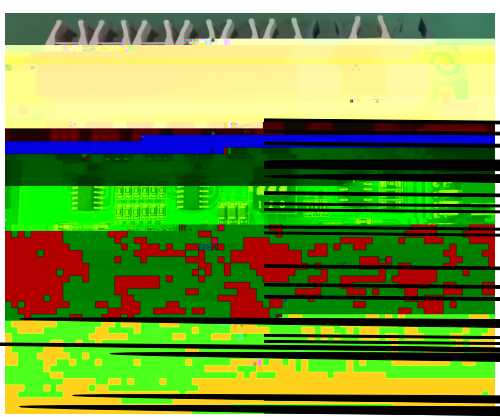
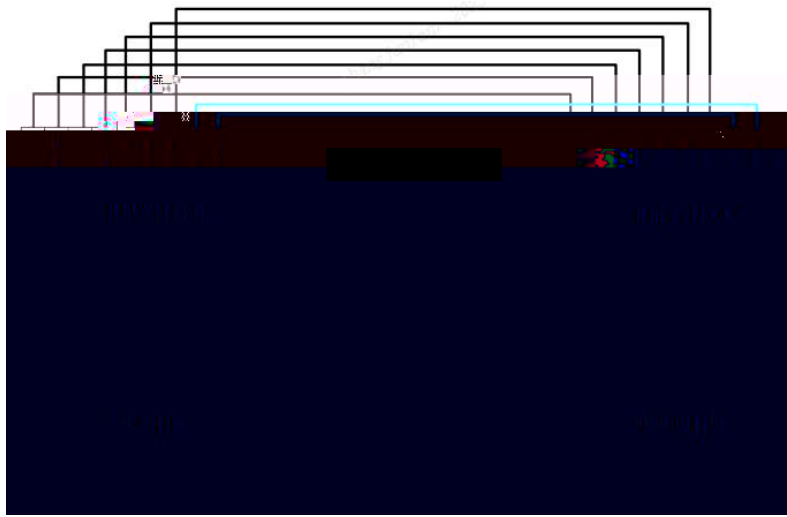



参数	名称	16	15	14	13	12	11	10	9	8	7	6	5	4	3	2
101.5	数字量输入端子 [01 ~ 16]															
101.6	数字量输出端子 [01 ~ 16]															

!B3

!B3



É

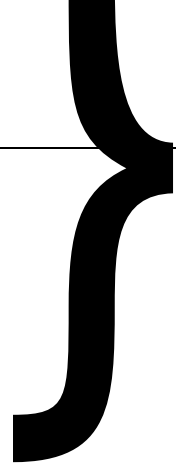

F9j

运行

停止

运行

\$

°Q

停止

Ã

O, Q É

停止

⊙

停止

↓



+E

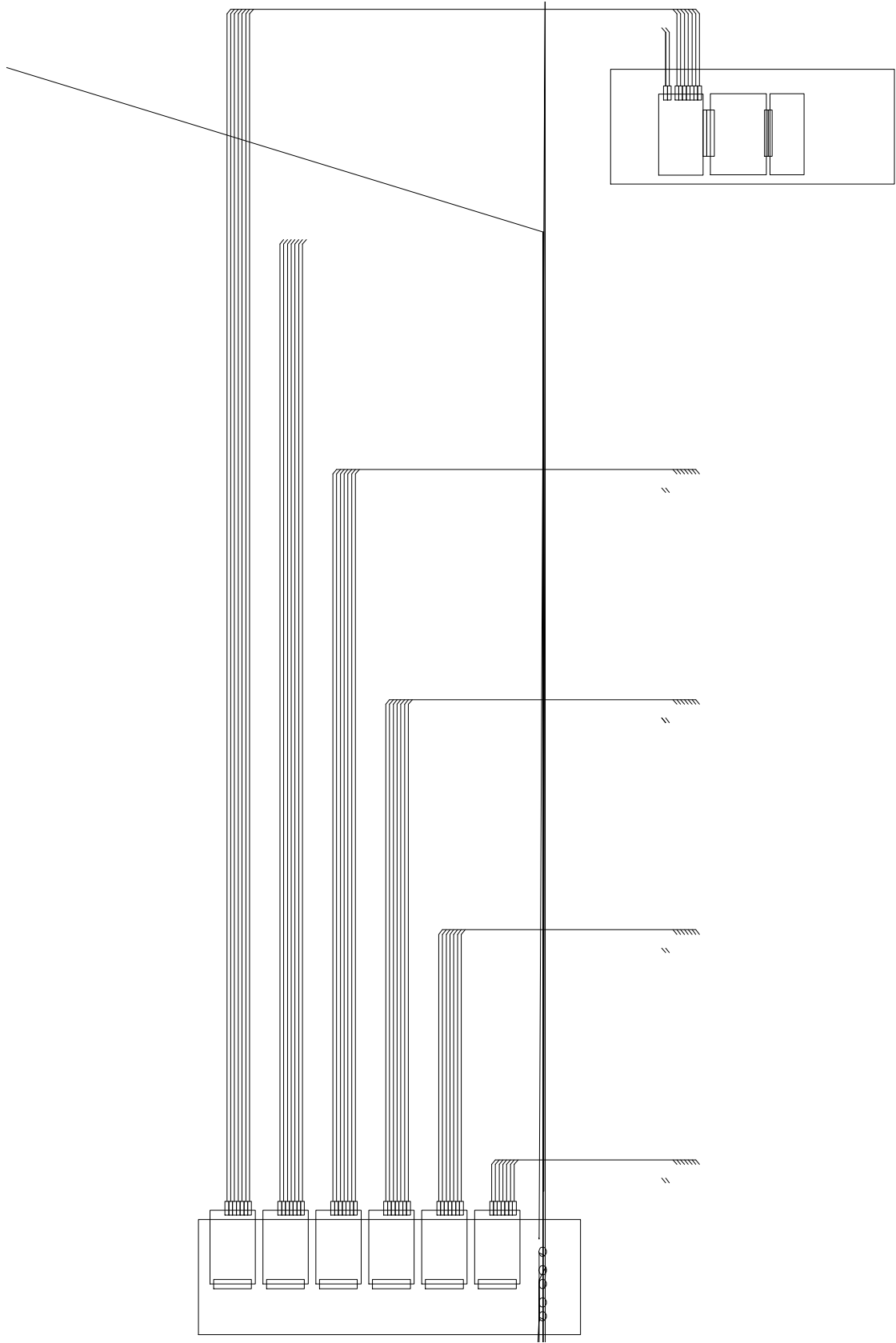



参数	名称	16	15	14	13	12	11	10	9	8	7	6	5	4	3	2
101.5	数字量输入端子 [01 ~															
101.6	数字量输出端子 [01 ~ 16]															

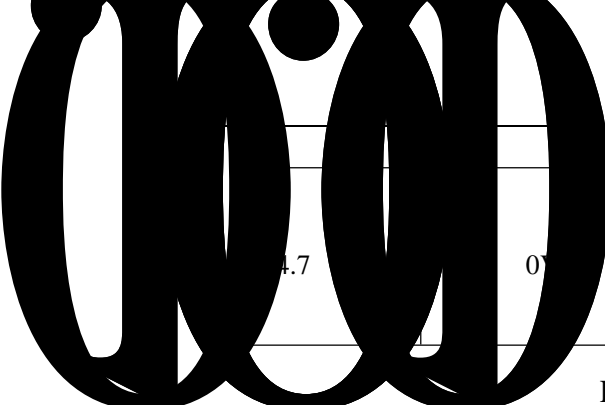

4.7

0V

ADJ

V1.12

P16.0

P24.7

=P16.0

+P24.7

P16.0 375V

580V

375V P16.0 400V

600V

400V P16.0 430V

630V

430V P16.0 450V

665V

450V P16.0 460V

680V

P16.0 460V

700V

620V

P16.0

380V

P24.7

20V

620V

220V

220V



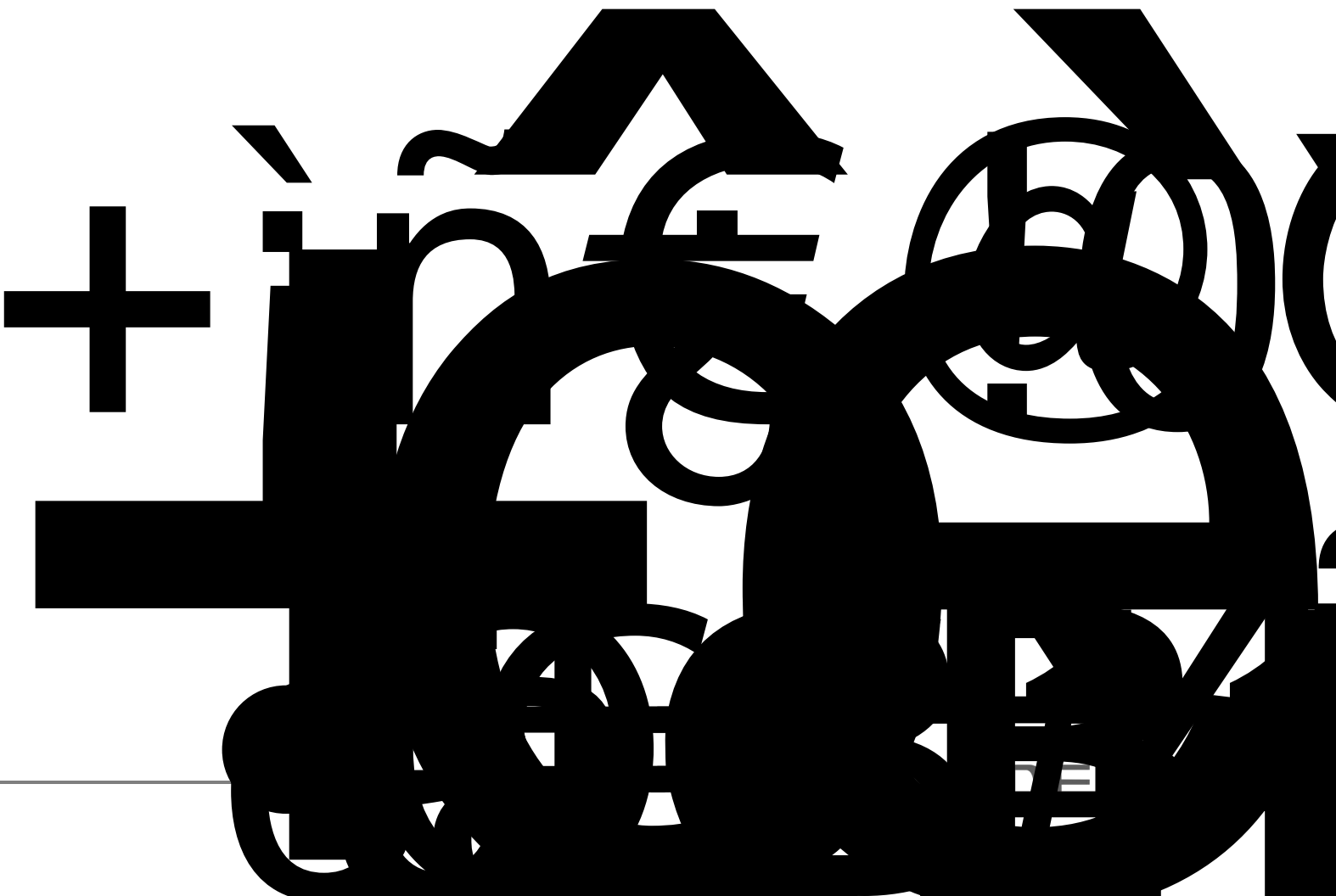

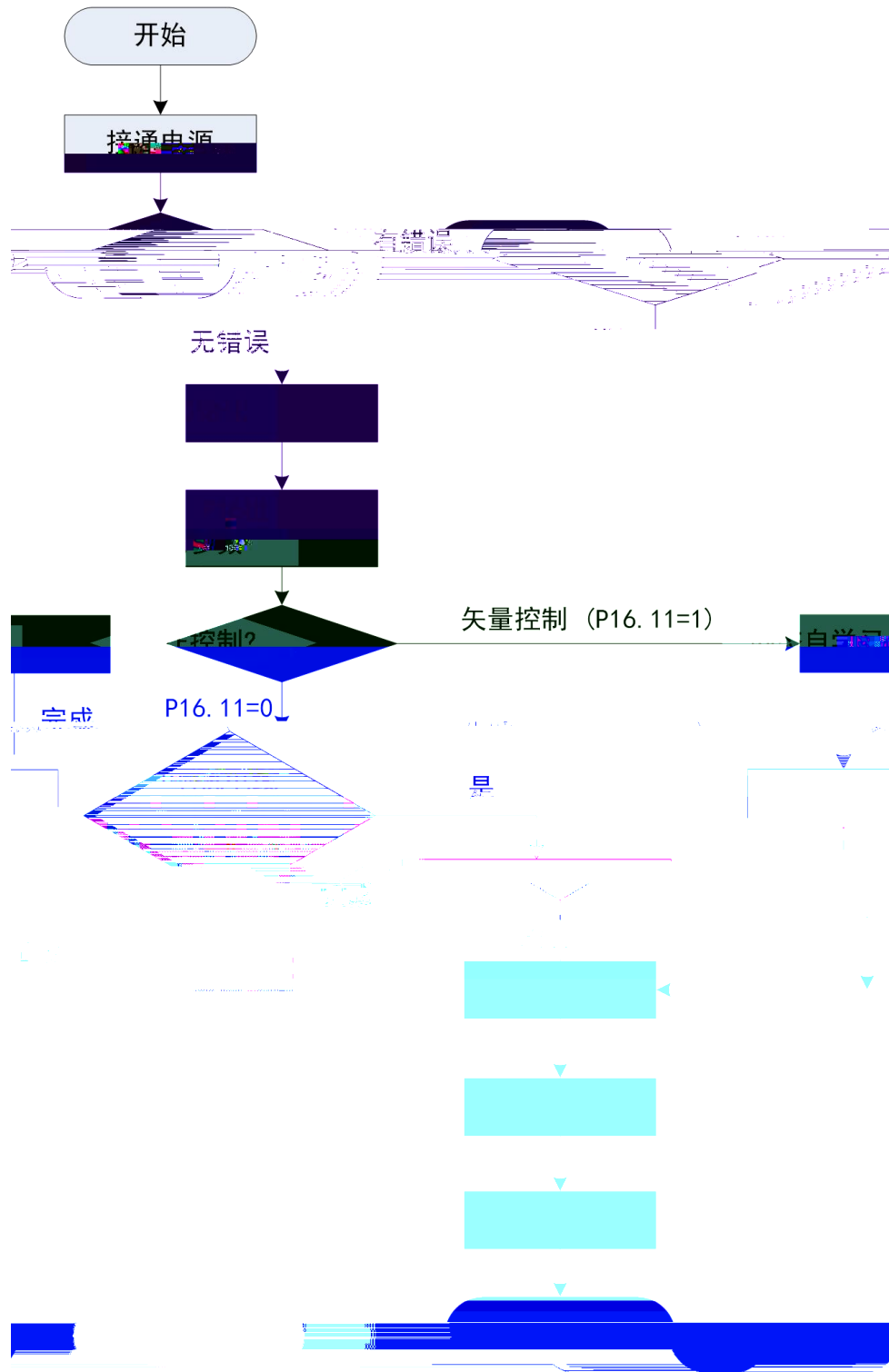

0.0Hz	560.5V	0A	N/N
电机速度[Hz] :		0 Hz	
给定频率[Hz] :		0 Hz	
母线电压 :		560 V	



0.0Hz	300V	0A	W/E
-------	------	----	-----









24

> 3. 22

> 6







Q+e• 25



NAB





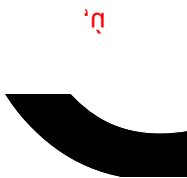



GUIDE

η Εταιρεία είναι μέλος της Ομάδας Αλφενεσ

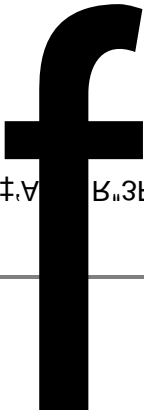





L€







ž Ÿ @D Ÿ" S°D °
\$Y b ypM!Ÿ" S°D °

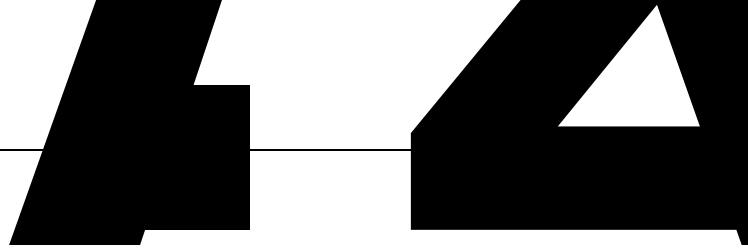



၁



400V

HF680NLC

250-630kW

GUIDE

1.00

Wuhan GUIDE Technology Co.,Ltd